

 ***Vertex Standard***

AIR BAND TRANSCEIVER

VX A-710

Operating Manual

SPIRIT

CONTENTS

Important Notice!	1	Scanning Operation	23
Introduction	2	Basic Scan	23
Control & Connectors	3	Channel-Skip Scanning	24
Top Panel	3	Programmable (Band Limit) Memory Scan (PMS)	24
Front Panel	4	Dual Watch Operation	25
Side Panel	5	Priority Dual Watch Operation	26
Keypad	6	Spectrum Scope Monitor	27
Before You Begin	8	VOR Navigation (AIR Band)	28
Precautions	8	To Select the VOR Mode	29
How to Install the Quick Draw Clip	8	Flying to a VOR Station	30
Installation of FNB-80LI Battery Pack	9	Entering a Desired Course	32
Battery Charging	9	Position Cross-checking	33
Installation of FBA-23 Alkaline Battery Case	10	Split Operation	34
Low Battery Indication	11	BRS (Business Radio service) Channel Operation	35
AC Operation Using NC-72B/C	11	Recalling the BRS channels	35
Basic Operation	12	CTCSS Operation	35
Preliminary Steps	12	DCS Operation	37
Operation Quick Start	12	CTCSS/DCS Bell Operation	38
Squelch Adjustment	13	Miscellaneous Setting	39
Accessing the 121.5 MHz Emergency Frequency	14	Automatic Power-Off (APO) Feature	39
Tuning Methods	14	Transmitter Time-Out Timer (TOT)	39
Transmission	15	Programming the Key Assignments	40
Reception of Weather Channel Broadcasts	16	Display Customization	41
Monitor Key	17	TX/BUSY Indicator Customization	42
ANL (Automatic Noise Limiter) Feature	17	Changing the Channel Step	43
LOCK Function	18	Field Programming Mode	44
Beep On/Off	18	CPU Resetting	45
Receive Battery Saver Setup	19	Timer Mode	46
Memory Operation	20	Menu ("Set") Mode	46
Memory System Operation	20	Specifications	56
Memory Storage	20	Accessories & Options	58
Recalling the Memories	21		
Memory Offset Tuning	21		
Deleting Memories	22		
Home Channel Memory	22		

IMPORTANT NOTICE!

FCC RF Exposure Compliance Requirements for Occupational Use Only:

This Radio has been tested and complies with the Federal Communications Commission (FCC) RF exposure limits for Occupational Use/Controlled exposure environment. In addition, it complies with the following Standards and Guidelines:

- ❑ FCC 96-326, Guidelines for Evaluating the Environmental Effects of Radio-Frequency Radiation.
- ❑ FCC OET Bulletin 65 Edition 97-01 (1997) Supplement C, Evaluating Compliance with FCC Guidelines for Human Exposure to Radio Frequency Electromagnetic Fields.
- ❑ ANSI/IEEE C95.1-1992, IEEE Standard for Safety Levels with Respect to Human Exposure to Radio Frequency Electromagnetic Fields, 3 kHz to 300 GHz.
- ❑ ANSI/IEEE C95.3-1992, IEEE Recommended Practice for the Measurement of Potentially Hazardous Electromagnetic Fields - RF and Microwave.
- **This radio is NOT approved for use by the general population in an uncontrolled environment. This radio is restricted to occupational use, work related operations only where the radio operator must have the knowledge to control its RF exposure conditions.**
- **When transmitting, hold the radio in a vertical position with its microphone 1 to 2 inches (2.5 to 5 cm) away from your mouth and keep the antenna at least 1 inch (2.5 cm) away from your head and body.**
- **The radio must be used with a maximum operating duty cycle not exceeding 50%, in typical Push-to-Talk configurations. DO NOT transmit for more than 50% of total radio use time (50% duty cycle). Transmitting more than 50% of the time can cause FCC RF exposure compliance requirements to be exceeded. The radio is transmitting when the red LED on the top of the radio is illuminated. You can cause the radio to transmit by pressing the P-T-T button.**
- Always use Vertex Standard authorized accessories.

NOTICE

There are no user-serviceable points inside this transceiver. All service jobs must be referred to your Authorized Service Center.

INTRODUCTION

The Vertex Standard **VXA-710 Spirit** is a compact, stylish, solid hand-held transceiver providing communication (transmit and receive) capability on the International Aircraft Communication Band (“COM” band: 118 ~ 136.975 MHz), and it additionally provides VOR and CDI navigation features on the “NAV” band (108 ~ 117.975 MHz). What’s more, it also is receiving on the FM BC Band, Weather Channel Broadcast (USA version only), and BRS (Business Radio Service) band.

The **VXA-710** includes Temperature display with our exclusive Omni-Glow™ display back-light for minimal degradation of your night vision, NOAA weather band monitoring, 8-character Alpha/Numeric Display, 70 Memory Channels, and 90 “Book Memory” Channels.

We recommend that you read this manual in its entirety, so as to understand the many features of the **VXA-710** completely. Keep this manual handy, so you may use it for reference.

NOTE: The VXA-710’s VOR and CDI Navigation features are supplemental aids to navigation only, and are not intended to be a substitute for accurate (primary) VOR/CDI or landing service equipment.

CONTROLS & CONNECTORS (TOP PANEL)

① Antenna Jack

This SMA jack accepts the supplied flexible antenna, or another antenna designed to provide 50 Ohm impedance on the Aircraft Communication Band and BRS Band.

② MIC/SP Jack

You may connect the supplied **CT-96** Headset Cable, or the optional **MH-44B4B** Speaker/Microphone, to this jack.

Never connect any Speaker/Microphone that is not recommended by the manufacturer. Because these jack connections are unique, using a Speaker/Microphone that is not specified by Vertex Standard may damage the **VXA-710**.

③ VOL Knob

This control adjusts the audio volume level. Clock-wise rotation increases the volume level.

④ DIAL Selector Knob

This 20-position detented rotary switch tunes the operating frequency or selects the memory channels.

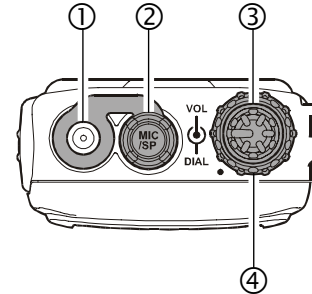

CONTROLS & CONNECTORS (FRONT PANEL)

① LCD (Liquid Crystal Display)

The display shows the current operating conditions, including frequency, etc.

② PWR (Power) Switch

Press and hold this switch for 3 seconds to toggle the transceiver's power on and off.

③ Keypad

Several keys have triple functions.

The primary functions are labeled on the key top (activated by simply pressing the key momentarily).

The secondary functions are labeled in yellow above the top edge of the key (activated by pressing the **F** key first, then the indicated key).

The third functions are labeled in black above the top edge of the key, and are activated by pressing and holding in the selected key for 2 seconds.

These functions are summarized on the pages 6 and 7.

④ BUSY/TX Indicator Lamp

This lamp glows green when a signal is being received and red when transmitting.

You may customize the color setup via the Menu mode.

⑤ Loudspeaker

The internal speaker is located in this position.

⑥ Microphone

Speak across this opening in a normal voice level, while pressing the **PTT** switch, to transmit.

⑦ Battery Pack Latch

Open this latch for battery removal.

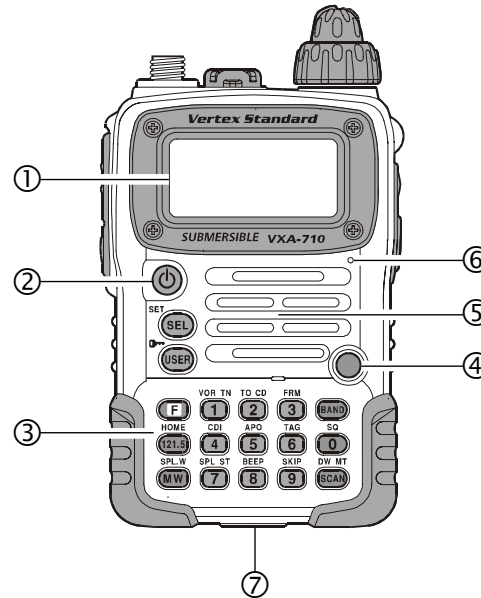

CONTROLS & CONNECTORS (SIDE PANEL)

① PTT (Push To Talk) Switch

Press this button to transmit when you are operating in the COM band (118.000 - 136.975 MHz). Release this button to return to the “Receive” mode. See page 15.

② MONITOR Switch

This button may be pressed to “Open” the squelch manually, allowing you to listen for very weak signals. Press and hold this button for 2 seconds to “Open” the squelch continuously. Press this button again to resume normal (quiet) monitoring. See page 17.

③ EXT DC Jack







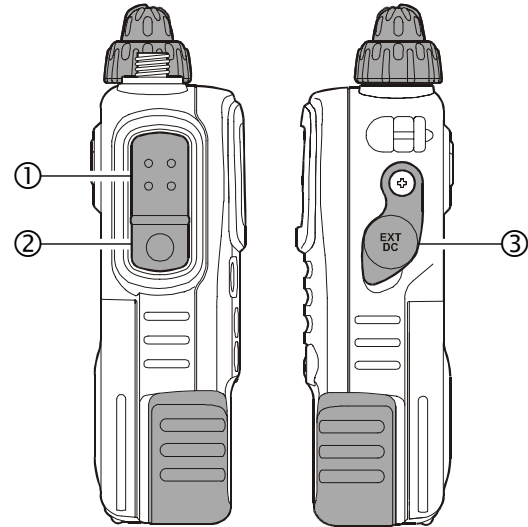





When an external 12-Volt DC power source is available, you may connect the (optional) **E-DC-5B** DC Cable w/Noise Filter or **E-DC-6** DC Cable here.















Do not connect any wire to this jack if that wire is connected directly to a 28-Volt DC source. Connecting the VXA-710 directly to a source which exceeds 15.0 Volts DC will result in damage to the unit.



CONTROL & CONNECTORS (KEYPAD)

		<small>VOR TM</small> 	<small>TO CD</small> 
Primary Function (Press Key)	Activates the “Secondary” key mode.	Frequency entry digit “1.”	Frequency entry digit “2.”
Secondary Function (Press + )	None	Activates VOR mode.	Selects “TO” VOR mode.
Third Function (Press and hold key)	None	Recalls Menu Item “SQL Type” (for activating CTCSS or DCS decoder on a BRS Memory Channel).	Recalls Menu Item “TONE Set” (for selecting the CTCSS tone frequency on a BRS Memory Channel).
	<small>HOME</small> 	<small>CDI</small> 	<small>APO</small> 
Primary Function (Press Key)	Selects the Emergency Channel (121.5 MHz).	Frequency entry digit “4.”	Frequency entry digit “5.”
Secondary Function (Press + )	Switches operation to the “Home” (favorite frequency) channel.	Activates the Course Deviation Indicator mode.	None
Third Function (Press and hold key)	None	None	Recalls Menu Item “APO” (for setting of the Automatic Power-Off time).
	<small>SPL W</small> 	<small>SPL ST</small> 	<small>BEEP</small> 
Primary Function (Press Key)	None	Frequency entry digit “7.”	Frequency entry digit “8.”
Secondary Function (Press + )	Split-Memory “Write” Command	Activates Split (Duplex) mode.	None
Third Function (Press and hold key)	Memory “Write” Command	Recalls Menu Item “Step” (for setting of the synthesizer steps).	Recalls Menu Item “Beep” (for setting of the keypad beeper).

CONTROL & CONNECTORS (KEYPAD)

FRM 			SET 
Frequency entry digit "3."	Toggles the operating band between the AIR band and FM BC band in the VFO mode.	Primary Function (Press Key)	Selects the tuning methods among the VFO, MR, BMR, WX, and BRS*1.
Selects "FROM" VOR mode.	None	Secondary Function (Press + )	Activates the "Set" (Menu) mode.
None	None	Third Function (Press and hold key)	None
TAG 	SQ 		 x2
Frequency entry digit "6."	Frequency entry digit "0."	Primary Function (Press Key)	Activates the Automatic Noise Limiter during AM reception.
Enables/Disables the Alpha-numeric Tag display during Memory operation.	None	Secondary Function (Press + )	Locks the Keypad.
None	Recalls Menu Item "SQL" (for setting the squelch threshold level).	Third Function (Press and hold key)	Switches the frequency display between the "Large Character" and "Small Character" mode.
SKIP 	DW MT 		
Frequency entry digit "9."	Activates the Scanner.	Primary Function (Press Key)	*1: VFO: Variable Frequency Oscillator MR: Memory Recall BMR: Pre-Programmed Memories WX: Weather Channel Memories BRS: Business Radio Service *2: The Primary and Third functions of the  key may be customized by user via the Menu mode. See page 40.
None	Activates Dual Watch.	Secondary Function (Press + )	
Sets the Memory Skip (Omit) feature to the current memory channel.	Activates the "Memory Tune" mode while in the Memory Recall mode.	Third Function (Press and hold key)	

BEFORE YOU BEGIN

Precautions

- This apparatus is capable of two-way communication on channels used for critical aviation safety communications. Therefore, it is important that this radio be kept away from children or other unauthorized users at all times.
- When making DC connections via the (optional) **E-DC-5B** DC cable, be absolutely certain to observe the proper voltage level and polarity guidelines. Do not connect this radio directly to any 24 ~ 28 Volt DC source, nor to AC power of any kind. Connecting the **VXA-710** directly to a source which exceeds 15.0 Volts DC will result in damage to the unit.
- Do not dispose of the LI-ion Battery Pack in a fire. Do not carry a LI-ion Battery Pack in your pocket, where keys or coins could short the terminals. This could create a serious fire/burn danger, and possibly cause damage to the LI-ion pack.

How to Install the Quick Draw Belt Clip

- Connect the hanger to the rear of the **VXA-710**, with the notch pointing directly up, using the supplied screw (Figure 1). Use only the screw included with the clip to mount the clip to the back of the **VXA-710**!
- Clip the Quick-Draw Belt Clip onto your belt (Figure 2).
- To install the **VXA-710** into the Quick-Draw Belt Clip, align the hanger with the Quick-Draw Belt Clip, and slide the **VXA-710** into its slot until a click is heard (Figure 3).
- To remove the **VXA-710** from the Quick-Draw Belt Clip, rotate the **VXA-710** 180 degrees, then slide the **VXA-710** out from the Quick-Draw Belt Clip (Figure 4).

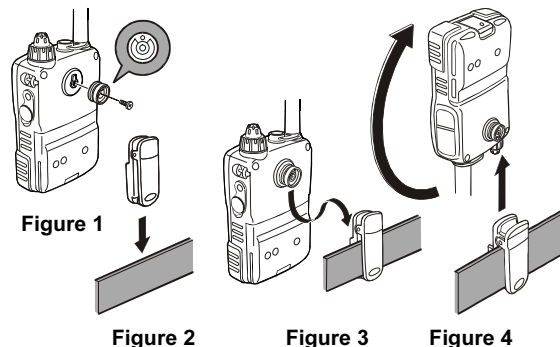



BEFORE YOU BEGIN

Installation of FNB-80LI Battery Pack

The **FNB-80LI** is a high-performance Lithium-Ion battery providing high capacity in a very compact package. Under normal use, the **FNB-80LI** may be used for approximately 300 charge cycles, after which operating time may be expected to decrease. If you have an old battery pack which is displaying capacity which has become diminished, you should replace the pack with a new one.

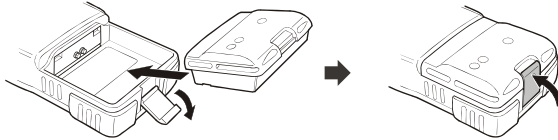
- ❑ Install the **FNB-80LI** as shown in the illustration.
- ❑ Close the Battery Pack Latch on the bottom of the radio.



 **Do not attempt to open any of the rechargeable LI-ion packs, as personal injury or damage to the LI-ion pack could occur if a cell or cells become accidentally short-circuited.**

Battery Charging

If the battery has never been used, or its charge is depleted, it may be charged by connecting the **NC-72B/C** Battery Charger, as shown in the illustration, to the **EXT DC** jack. If only 12 ~ 15 Volt DC power is available, the optional **E-DC-5B** DC Cable (w/cigarette lighter plug) or **E-DC-6** DC Cable may also be used for charging the battery, as shown in the illustration. “Now Charging . . .” will blink in the display while the battery is being charged. When charging is finished (approximately five hours), the display will change to indicate “Complete” and the **BUSY/TX** indicator will blink blue.

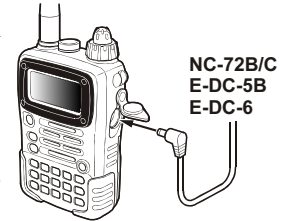

Important Notes:

- Do not leave the charger connected to the transceiver for continuous periods in excess of 24 hours. Long term overcharging can degrade the LI-ion battery pack and significantly shorten its useful life.
- If using a charger other than the **NC-72B/C**, or if using a battery pack other than the **FNB-80LI**, follow the appropriate instructions provided with the charger/battery. Contact your Dealer if you have any doubts about the appropriateness of the particular charger or battery pack you intend to use.

BEFORE YOU BEGIN

Installation of

FBA-23 Alkaline Battery Case (Option)

The optional **FBA-23** Battery Case allows receive monitoring using two “AA” size Alkaline batteries.

To Install Alkaline Batteries into the **FBA-23**

- Slide the batteries into the **FBA-23** as shown in the illustration, with the Negative [-] side of the batteries touching the spring connections inside the **FBA-23**.
- Open the Battery Pack Latch on the bottom of the radio.
- Install the **FBA-23** into the battery compartment on the back of the transceiver, then close the Battery Pack Latch on the bottom of the radio.

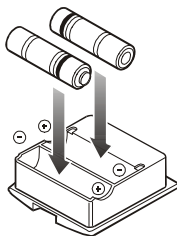



The **FBA-23** does not provide connections for charging, since Alkaline cells cannot be re-charged. Therefore, the **NC-72B/C**, **E-DC-5B**, or **E-DC-6** may safely be connected to the **EXT DC** jack when the **FBA-23** is installed.

Notes:

- The **FBA-23** is designed for use only with AA-type Alkaline cells.
- If you do not use the **VXA-710** for a long time, remove the Alkaline batteries from the **FBA-23**, as battery leakage could cause damage to the **FBA-23** and/or the transceiver.

BEFORE YOU BEGIN

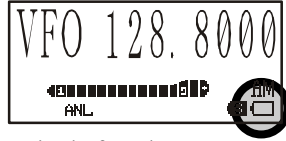
Low Battery Indication

- As you battery discharges during use, the voltage will gradually become lower. When the “The image shows a close-up of the LCD display on a radio. The display shows 'VFO 128.8000' in large digits. Below the frequency, there is a battery level indicator consisting of a row of 10 small battery icons, with the first few on the left being filled and the rest empty. Below the battery indicator, the text 'ANL' is visible. To the right of the battery indicator, there is a circular icon of a battery with a lightning bolt, indicating a low battery warning.

AC Operation Using NC-72B/C (Receiving only)

The **VXA-710** may be operated from your house current by use of the supplied **NC-72B/C** Battery Charger. The **NC-72B/C** should only be used for reception, because it is not capable of supplying sufficient current to support transmission.

To use the **NC-72B/C**, turn the transceiver off, then plug the miniature connector of the Battery Charger into the **EXT DC** jack on the side of the radio. Now plug the Battery Charger into the wall outlet. You may now turn on the transceiver.

BASIC OPERATION

Preliminary Steps

- ❑ Install a charged battery pack onto the transceiver, as described previously.
- ❑ Screw the supplied antenna onto the Antenna jack. Never operate this transceiver without an antenna connected.
- ❑ If you have an optional Speaker/Microphone or headset, we recommend that it not be connected until you are familiar with the basic operation of the **VXA-710**.

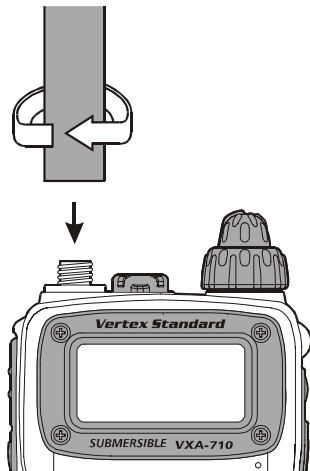

Operation Quick Start

- ❑ To turn the radio on, press and hold in the **(PWR)** Switch for 3 seconds.
- ❑ The opening message will appear on the display, then frequency display will appear.
- ❑ Press the **(BAND)** key to switch the operating band between the AIR band and FM BC band.
- ❑ Directly entering frequencies from the keypad is the easiest method

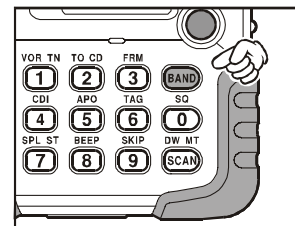
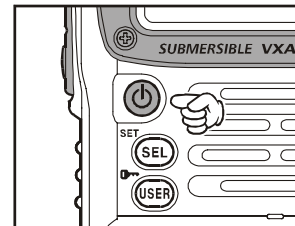

if you know the frequency on which you wish to operate. Just enter the five digits of the frequency to move to that frequency. However, there is a short-cut for frequencies ending in zero - press the **(SCAN)** key after the last non-zero digit.

For example, to set 134.35 MHz,

press **(1)** → **(3)** → **(4)** → **(3)** → **(5)**.

To set 118.000 MHz:

(1) → **(1)** → **(8)** → **(SCAN)**.

BASIC OPERATION

To set 118.275 MHz, you do not need to press the final “5” in the frequency:

VOR TN → VOR TN → BEEP → TO GO → SPL ST
① → ① → ⑧ → ② → ⑦.

Note: When the entered frequency is outside of the current operating band, the entry is ignored (i.e. **VXA-710** does not permit entry of an FM BC band frequency while operating in the AIR band).

- ❑ You may also turn the top panel’s **DIAL** selector knob to choose the desired operating frequency. The channel frequency will appear on the LCD.

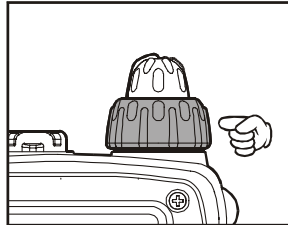

- ❑ To change frequency in 1 MHz steps, press the **[F]** key momentarily, then rotate the **DIAL** selector knob to select the MHz digit desired. Press the **[F]** key once more to resume normal channel step.

- ❑ Rotate the **VOL** knob to set the volume level. If no signal is present, press and hold in the **MONITOR** button for 2 seconds; background noise will now be heard,

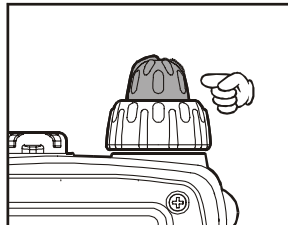

and you may use this noise to set the **VOL** knob for the desired audio level. Press the **MONITOR** button momentarily to silence the noise and resume normal (quiet) monitoring.

- ❑ To turn the radio off, press and hold in the **[PWR]** switch for 3 seconds.

Squelch Adjustment

- ❑ Press and hold in the **[SO]** key for 3 seconds. This instantly recalls Menu Item “SQL” on the Air Band, Weather Channel, or BRS Band or “FM Radio SQL” on the FM BC band.



- ❑ Press the **[SET SEL]** key to enable adjustment of this Menu Item.
- ❑ Rotate the **DIAL** selector knob to set the squelch threshold (0 - 8) so that the receiver is just silenced. A higher number indicates that a higher signal level is required in order to open the squelch.
- ❑ When you have made your setting, press the **[SET SEL]** key to save the new setting, then press the **PTT** key repetitively until the radio exits to normal operation.

BASIC OPERATION

Accessing the 121.5 MHz Emergency Frequency

The **VXA-710** can quickly access the 121.500 MHz Emergency Frequency. This function can be activated even when the keypad lock function is in use.

- ❑ To access the Emergency Frequency, press the **HOME** **121.5** key momentarily.

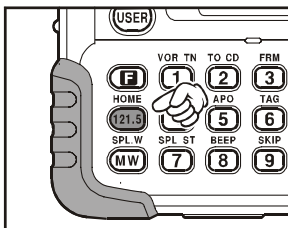

- ❑ To exit the Emergency Frequency, press the **SET** **SEL** key momentarily.

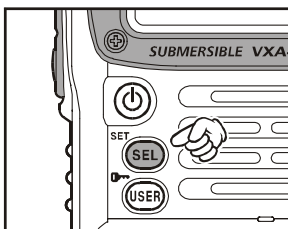

Tuning Methods

Throughout this manual, you will see references to several different frequency setting methods. Each will be particularly useful in a particular operating situation, and they are described below:

○ VFO (Variable Frequency Oscillator)

The VFO is a “tuning dial” system which allows you to tune through the AIR band and FM BC band using the **DIAL** selector, the Keypad, or the scanner. To select these bands, press the **MODE** **BAND** key momentarily.

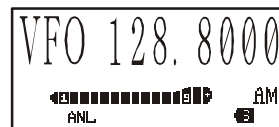

○ MR (Memory Recall)

The MR (Memory Recall) mode of the **VXA-710** provides the user with the ability to store and recall as many as 68 channels in the radio’s main memory bank. These memory channels may also be labeled by you with an alpha/numeric name of up to 8 characters in length, to aid in quick identification of the channel. See page 20 for details on creating alpha/numeric labels.

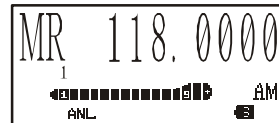

BASIC OPERATION

○ BOOK (Pre-Programmed) Memories

The Book memories are pre-programmed, either at the factory or by your Dealer (depending on your country's requirements), typically including the major AIR band station frequencies used in your area. The Book memories can be changed by the user. See page 44 for details.



○ WX (Weather Channel) Memories (USA version only)

Ten Weather Channels are pre-programmed at the factory. The **VXA-710** will automatically scan this special bank when it is selected by the user.

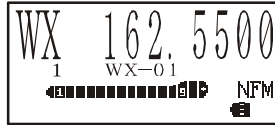

○ BRS (Business Radio Service) Memories

22 BRS Channels are pre-programmed at the factory. See page 35 for details of BRS Memory Channel Operation.

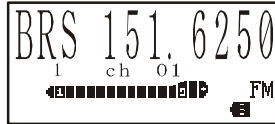

Transmission

- To transmit, press and hold in the **PTT** switch. Speak into the microphone area of the front panel grille in a normal voice level.
- To return to the receive mode, release the **PTT** switch.

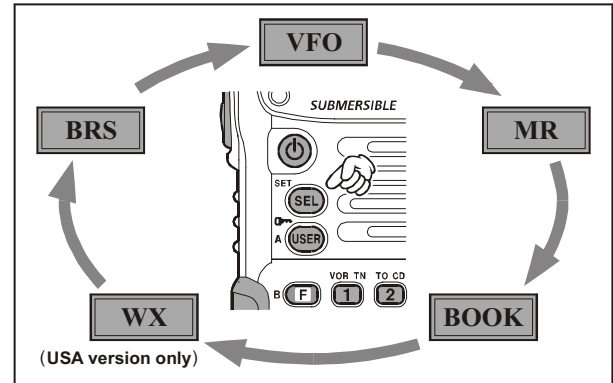
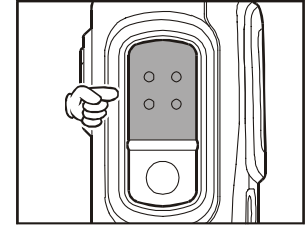

BASIC OPERATION

Reception of Weather Channel Broadcasts (USA version only)

The **VXA-710** can receive VHF Weather Channel broadcasts, which may assist your flight planning. The **VXA-710** includes a ten-channel auto-search feature, which simplifies access to Weather Channels when you are in an unfamiliar location.

- ❑ To receive Weather Channels, press the **SEL** key (repeatedly, if necessary) to select the Weather Channel mode. In the Weather Channel mode, “WX” will appear upper left corner of the display.

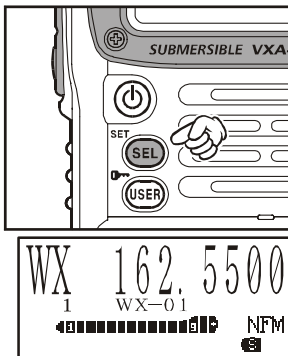

- ❑ The **VXA-710** will now scan quickly through the ten standard Weather Channels, and will stop on the first active station found.
- ❑ If there are two or more weather channels audible in your area, you may select the alternate channel(s) by pressing the **PTT** switch. Pressing the **PTT** switch re-initiates the scanning process.

- ❑ If there are no Weather Channels in your area, the scanner will not stop. Press the **MONITOR** button to stop the scanner.
- ❑ You can also select Weather Channels manually by rotating the **DIAL** selector knob.
- ❑ To exit the Weather Channel mode, press the **SEL** key momentarily to return to the VFO mode.

Channel	Frequency
WX 1	162.5500 MHz
WX 2	162.4000 MHz
WX 3	162.4750 MHz
WX 4	162.4250 MHz
WX 5	162.4500 MHz
WX 6	162.5000 MHz
WX 7	162.5250 MHz
WX 8	161.6500 MHz
WX 9	161.7750 MHz
WX 10	163.2750 MHz

Note 1: In the event of extreme weather disturbances, such as storms and hurricanes, the NOAA (National Oceanic and Atmospheric Administration) sends a weather alert accompanied by a 1050 Hz tone and subsequent weather report on one of the NOAA weather channels. You may setup the Alert function when receiving the Weather Alert signal via Menu Item (6. Misc Setup, 3. WX Alert), if desired.

Note 2: The Weather Channel mode memorizes the last Weather Channel you have used, and will retain this information until the radio is turned off.

BASIC OPERATION

Monitor Key

When listening to a very weak signal from an aircraft or ground station, you may observe the signal disappearing periodically as the incoming signal strength becomes too weak to override the squelch threshold setting.

To disable the squelch temporarily, press and hold the **MONITOR** key for 2 seconds on the left side of the radio, just below the **PTT** button. The “🔊” icon will appear on the display, and the squelch will remain open and you should have a better chance of hearing weak signals.

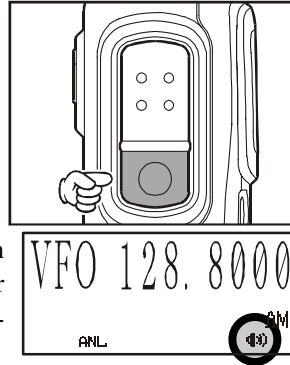

To return to normal operation, press the **MONITOR** key momentarily; the “🔊” icon will disappear from the display.

ANL (Automatic Noise Limiter) Feature

For reduction of impulse noise, such as that produced by an engine's ignition system, the ANL feature may prove helpful.

- ❑ To activate the ANL feature, press the **USER** key momentarily. The “ANL” icon will appear on the display, and you should observe a reduction in the ignition noise.
- ❑ To turn the ANL feature off, press the **USER** key again; the “ANL” icon will disappear from the display.

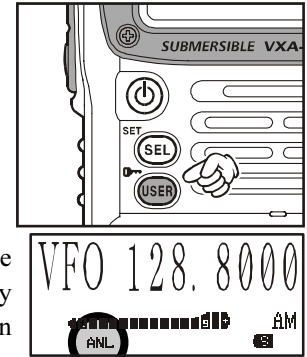

Note: The ANL feature is only activated on the Air Band.

BASIC OPERATION

LOCK Function

The lock function prevents accidental changes to the frequency setting and the keypad controls.

- ❑ To activate the lock feature, press the **F** key followed by the **USER** key.
- ❑ In the LOCK mode, the “**🔒**” icon will appear on the display.
- ❑ To turn the lock feature off, press the **F** key followed by the **USER** key again; the “**🔒**” icon will disappear from the display.
- ❑ You can still access the 121.500 MHz Emergency Frequency when the LOCK function is on. Simply press the **HOME** **121.5** key momentarily (this key never locks). Pressing this key also unlocks the radio.

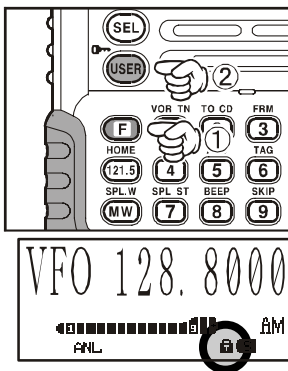

Beep On/Off

The **VXA-710**'s key/button beeper provides convenient audible feedback whenever a button is pressed. Each key and button has a different beep pitch, and each function has a unique beep combination.

When you are scanning, the beeper will be heard each time the scanner halts on a busy channel. This may be distracting in some environments; if you want to turn the beeper off (or back on again):

- ❑ Press and hold the **BEEP** **8** key for 2 seconds. This instantly recalls Menu Item “Beeper.”
- ❑ Press the **SET** **SEL** key to enable adjustment of this Menu Item.
- ❑ Rotate the **DIAL** selector knob to select the desired selection.
 - On: Sounds a keypad beeper corresponding to a musical note.
 - DTMF: Sounds a keypad beeper corresponding to a DTMF tone.
 - Off: Keypad beeper is “off.”
- ❑ When you have made your selection, press the **SET** **SEL** key to save the new setting, then press the **PTT** key repetitively until the radio exits to normal operation.



BASIC OPERATION

Receive Battery Saver Setup

An important feature of the **VXA-710** is its Receive Battery Saver, which “puts the radio to sleep” for a time interval, periodically “waking it up” to check for activity. If somebody is talking on the channel, the **VXA-710** will remain in the “active” mode, then resume its “sleep” cycles. This feature significantly reduces quiescent battery drain, and you may change the amount of “sleep” time between activity checks using the Menu System:

- Press the **[F]** key, then press the **[SET SEL]** key to activate the Menu (“SET”) mode.
- Rotate the **DIAL** selector knob to select Menu Item “3. Receive,” then press the **[SET SEL]** key.
- Rotate the **DIAL** selector knob to select Sub Menu Item “5. RX Save,” then press the **[SET SEL]** key.
- Press the **[SET SEL]** key again to enable adjustment of this Menu Item.
- Rotate the **DIAL** selector knob to select the desired “duty cycle” (receive:sleep). The selections available are 1:1, 1:2, 1:3, 1:4, 1:5, and ABS* or OFF. The default value is ABS.
- When you have made your selection, press the **[SET SEL]** key to save the new setting, then press the **PTT** key repetitively until the radio exits to normal operation.

*ABS: Automatic Battery Saver, based on activity on the receiver.

The setting of 1:5 will promote the greatest conservation of battery capacity, but the receiver’s response time to incoming calls will be slowed somewhat.

Note: The Receive Battery Saver feature does not operate during Scan, Dual Watch, or Spectrum Scop Monitoring.

MEMORY OPERATION



The **VXA-710** provides 70 user-programmable Main memories, labeled “MR1” through “MR68”, “MRLch,” and “MRUch,” up to 90 pre-programmed memories, designated “Book” Memories, labeled “BMR1” through “BMR90,” and one Home channel, allowing storage and quick recall of favorite operating frequency.

The Main memories and “Book” Memories can be assigned alpha-numeric names of up to eight characters.







Memory System Operation

The **VXA-710**'s Main Memory system allows the user to store, label, and recall channel frequencies which you may want to use frequently. You may store VFO frequencies, “Book” Memory frequencies, and/or Weather Channel frequencies (USA version only) into the Main Memory system.

Memory Storage





- ❑ Select the desired frequency in the VFO mode, or recall the “Book” Memory channel or Weather channel to be stored in the Main Memory.
- ❑ Press and hold in the  key for 2 seconds. The display will indicate “MW” and a channel number will blink on the LCD.
- ❑ Within five seconds of pressing the  key, rotate the **DIAL** selector knob to select the desired memory chan-



nel number for storage. In order to prevent writing over memory channels, an “” icon will appear at the right of the channel number to indicate if the memory channel is vacant.



- ❑ Now press and hold in the  key for 2 seconds; you will now see the blinking “A” character on the LCD. To attach an alpha/numeric name (label) to the memory, proceed to the next step; otherwise press and hold in the  key for 2 seconds to save the entry and exit.
- ❑ To label a memory with an alpha/numeric name, the next step is to use the **DIAL** selector knob to select any of the 125 available characters (including letters, numbers, and special symbols). Press the  key repeatedly to recall the desired letter, number, and symbol in the first character slot (a → . → □ → A → a ...). When the desired first character appears, press the  key momentarily to select it and move on to the next character.
- ❑ Select succeeding characters in the same manner, pressing the  key momentarily after each selection.
- ❑ After entering the entire name (eight characters maximum), press the  key for 2 seconds to save all data for the channel and exit.

MEMORY OPERATION

Recalling the Memories



- ❑ Press the  key, repeatedly if necessary, until “MR” (Memory Recall) appears on the display. In the MR mode, you will see the previously-selected channel number appearing at the bottom of the “MR” icon on the LCD.
- ❑ Rotate the **DIAL** selector knob to select the desired memory channel.
- ❑ You may change the readout structure of the Memory display between “Frequency Indication” and “Frequency Indication plus Alpha-numeric Label” by pressing the  key followed by the  key.
- ❑ To exit the Memory mode, press the  key four times to return to the VFO mode.

Note 1: In either the Memory mode or the “Book” Memory mode, an easy way to recall memories is to key in the memory channel number (except memory channel “Lch” and “Uch”). For example, to recall memory channel #06, press  → .

Note 2: In either the Memory mode or the “Book” Memory mode, you can change memory channels in 10-channel steps: press the  key momentarily, then rotate the **DIAL** selector knob. The “” icon will show at the left bottom of the display when the 10-channel-step tuning mode is active. Press the  key once more to resume normal channel selection in one-channel steps.

Memory Offset Tuning

Once you have recalled a particular memory channel, you may easily tune off that channel, as though you were in the “VFO” mode.

- ❑ With the **VXA-710** in the Memory Recall mode, select the desired memory channel.
- ❑ Now press and hold in the  key for 2 seconds. The “MR” indicator will be replaced by one which says “MT” (Memory Tuning).
- ❑ Rotate the **DIAL** selector knob, as desired, to tune to a new frequency. The synthesizer steps selected for VFO operation on the current band will be the steps used during Memory Tuning.
- ❑ If you wish to return to the original memory frequency, press and hold in the  key for 2 seconds. The “MT” indicator will be replaced by “MR”.
- ❑ If you wish to store a new frequency set during Memory Tuning, just press and hold in the  key for 2 seconds, per normal memory storage procedure.

Note: The Memory Offset Tuning feature will not engage on any memories on which BRS channels are stored.

MEMORY OPERATION

Deleting Memories

- ❑ With the **VXA-710** in the Memory mode, rotate the **DIAL** selector knob to select the memory channel you wish to delete.
- ❑ Press the **(F)** key, then press and hold the **(SPL W MW)** key for 2 seconds. The previously-selected memory will be deleted.

Note: Once deleted, channel data cannot be recovered!

Home Channel Memory

A special “HOME” channel is available, to allow quick recall of a favorite operating frequency. Memory storage is simple to accomplish:

- ❑ Select the desired frequency in the VFO mode, or recall the “Book” Memory channel or Weather channel to be stored in the “HOME” channel.
- ❑ Press and hold in the **(SPL W MW)** key for 2 seconds. The display will indicate “MW” and a channel number will blink on the LCD.
- ❑ Within five seconds of pressing the **(SPL W MW)** key, press and hold in the **(HOME 21.5)** key for 2 seconds. The frequency and other data (if any) will now be stored in the special “HOME” channel register.
- ❑ To recall the “HOME” channel, press the **(F)** key followed by the **(HOME 121.5)** key.

You may also attach an alpha/numeric name (label) to the “HOME” channel.

- ❑ Recall the “HOME” channel, by pressing the **(F)** key followed by the **(HOME 121.5)** key.
- ❑ Now press and hold in the **(SPL W MW)** key for 2 seconds; you will now see the blinking “A” character on the LCD. Use the **DIAL** selector knob to select any of the 125 available characters (including letters, numbers, and special symbols). Press the **(USER)** key repeatedly to recall the desired letter, number, and symbol in the first character slot (a → . → 0 → A → a ...). When the desired first character appears, press the **(SET SEL)** key momentarily to select it and move on to the next character.
- ❑ Select succeeding characters in the same manner, pressing the **(SET SEL)** key momentarily after each selection.
- ❑ After entering the entire name (eight characters maximum), press the **(SPL W MW)** key for 2 seconds to save all data for the channel and exit.
- ❑ Press the **(F)** key followed by the **(TAG RPT 6)** key to change the readout structure of the Memory display between “Frequency Indication” and “Frequency Indication plus Alpha-numeric Label.”

SCANNING OPERATION

Basic Scan

The **VXA-710** allows you to scan automatically in the VFO*¹, Main Memory, “Book” Memory, Weather Channel*² or BRS Memory modes. It pauses on signals encountered, so you can talk to the station(s) on that frequency, if you like.

*1: In the VFO mode, the automatic scanner is only available in the current operating band (AIR band or FM BC band). Furthermore, on the AIR band, the automatic scanner is only available in the COM band (118.000 - 136.975 MHz); when the scanner reaches the uppermost frequency in the COM band, it will revert to the bottom end of the COM band and repeat the scanning process until you cancel the scanning process.

*2: USA version only.

If you wish to scan in the NAV band (108.000 - 117.975 MHz), you can do so manually, as described below.



Scanning operation is basically the same in each of the above modes.

- Press the  key momentarily to start the automatic scanner upward (toward a higher frequency or a higher channel number).
- When the scanner encounters a signal, scanning pauses and the radio remains on that channel until one sec-

ond after the signal disappears, after which scanning will resume.

- While the scanner remains paused on a frequency, the decimal point of the frequency display blinks. The display will be illuminated unless the Scan Lamp Feature is turned off.
- To change the scan direction, turn the **DIAL** selector knob one click in the opposite direction.
- To stop the automatic scanner, press the **PTT** switch or the  key momentarily.

The **VXA-710**'s automatic scanner is not operational in the NAV band (108.000 - 117.975 MHz), because the NAV stations (ILS, etc.) transmit constantly (thereby causing the scanner to stop repeatedly). However, you can scan manually in the NAV band, per the following procedure:

- Press and hold the  key to start the manual scanner. Scanning will continue as long as the key is depressed.
- Release the  key to stop the manual scanner immediately.

Note: When scanning upward in frequency, when the frequency reaches the COM Band (118.000 - 136.975 MHz) via manual scanning, the **VXA-710** will switch to the automatic scanner mode.

SCANNING OPERATION

Channel-Skip Scanning

Continuous-carrier stations like ATIS (Automatic Terminal Information Service) or Weather Broadcast stations inhibit scanner operation. Since these stations are always active, the scanner will be halted repeatedly on their channels. Such channels can be set to be “Skipped” during Memory scanning (MR, Book, WX, or BRS modes), if you like, so as not to interfere with automatic channel scanning:





- ❑ Recall the Memory Channel to be skipped during scanning.
- ❑ Press and hold the  key for 2 seconds. The “◀” icon will appear at the left of the frequency display, indicating that the channel is to be ignored during scanning.
- ❑ Later, to re-enable the memory channel for scanning, repeat the first two steps. The “◀” icon will disappear by the channel you have just re-enabled.

Note: A memory set to be “Skipped” is still accessible for manual memory selection using the **DIAL** selector knob.



Programmable (Band Limit) Memory Scan (PMS)

This feature allows you to set sub-band limits for either scanning or manual VFO operation. For example, you might wish to set up a limit of COM band (118.000 MHz to 136.975 MHz). Here's how to do this:

- ❑ Set the radio to the VFO mode by pressing the  key and set the radio to the AIR band by pressing the  key, if necessary.
- ❑ Using the techniques learned earlier, store 118.000 MHz into Memory Channel “Lch” (the “Lch” designates the Lower sub-band limit).
- ❑ Likewise, store 136.975 MHz into Memory Channel “Uch” (the “Uch” designates the Upper sub-band limit).
- ❑ Switch to the Memory mode by pressing the  key once, then rotate the **DIAL** to select Memory Channel “Lch.”
- ❑ Press and hold in the  key for 2 seconds to start PMS operation; the “MR” label will be replaced by “PMS” in the upper left-hand corner of the display.
- ❑ Tuning and scanning (pressing the  key) will now be limited within the just-programmed range.

Note: The PMS feature will not engage if a BRS channel is stored in either the “Lch” or “Uch” memory slot.

DUAL WATCH OPERATION

The Dual Watch feature automatically checks for activity on a “Priority” channel* while you are operating on another channel. During Dual Watch operation, the current channel and the Priority channel will each be polled for a 500 ms interval, as the **VXA-710** looks for activity on each channel.

- To start Dual Watch, press the **(F)** key followed by the **(SCAN)** key.
- The “DW” icon will appear on the display.
- While receiving on the “current” channel (not the Priority channel), you may push the **PTT** switch at any time to transmit on that channel.
- When a signal is received on the Priority channel, operation immediately shifts to the Priority channel; the “DW” icon will blink, and the display will become illuminated.

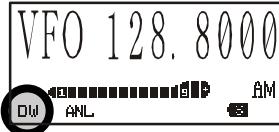

- While receiving on the priority channel, if you momentarily press the **PTT** switch, Dual Watch will be disabled. You may then transmit on the Priority Channel.
- To stop Dual Watch, press the **(F)** key followed by the **(SCAN)** key.
- If you wish, you may use both the Dual Watch and Scan features simultaneously. To do this, start the Dual Watch first, then start the Scanner.

* The “Priority” channel is defined as the last-used Memory Channel (when using the VFO, “Book” memory, and “BRS” modes) or Memory Channel “1” (when using the Main Memory mode).

PRIORITY DUAL WATCH OPERATION

Similar to Dual Watch operation (described on previous page), Priority Dual Watch is an enhanced version which includes the following additional features:

- The receiving time interval (ratio) between the current channel and the Priority channel may be customized via the Menu Item “PRI Time.” See page 51 for details.
- Irrespective of which channel is currently being received, when the **PTT** button is pushed transmission will always occur on the Priority channel.

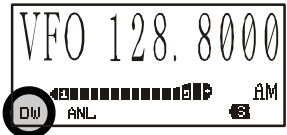

Before initiating Priority Dual Watch, Menu Item “DW/PRI” must be set to the “PRI” mode (instead of “DW”). See page 50 for details.

- To start Priority Dual Watch, press the **(F)** key followed by the **(SCAN)** key. The “DW” icon will appear on the display.
- While receiving on the “current” (non-Priority) channel, pressing the **PTT** button once causes the radio to switch to the Priority channel and cancels Dual Watch. Press the **PTT** button again to transmit on the Priority channel.
- When a signal is received on the Priority channel, reception immediately shifts to the Priority channel; the “DW” icon will blink, and the display will become illuminated unless the Scan Lamp Feature is turned off.
- While receiving on the Priority channel, if you momentarily press the **PTT** switch, Priority Dual Watch will be disabled. You may then transmit on the Priority Channel.
- To stop Priority Dual Watch, press the **(F)** key followed by the **(SCAN)** key.

SPECTRUM SCOPE MONITOR

If you assign the Spectrum Scope Monitor feature to the  key (see page 40), you may view operating activity on channels above and below the current operating channel while operating in the VFO, Memory Tune, and PMS modes.

The display indicates the relative signal strength on channels immediately adjacent to the current operating frequency.

- Set the radio to the VFO mode by pressing the  key, if necessary.
- Press (or press and hold in) the  key to activate the Spectrum Scope Monitor.

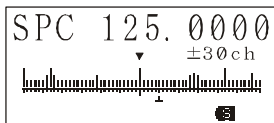

- Once the Spectrum Scope Monitor is activated, press the  key to change the visible bandwidth between ± 15 channels and ± 30 channels (default: ± 30 channels). The visible bandwidth, however, depends on the selected channel step size, so match the channel step to those typically used in your area.
- To turn the Spectrum Scope Monitor off and operate on the centered (and displayed) channel, simply press the **PTT** switch.

Note 1: Audio output will be interrupted during Spectrum Analyzer operation. This is normal.

Note 2: The Spectrum Scope Monitor may not be activated on the BRS Memories.

VOR NAVIGATION (AIR BAND)

General VOR Equipment

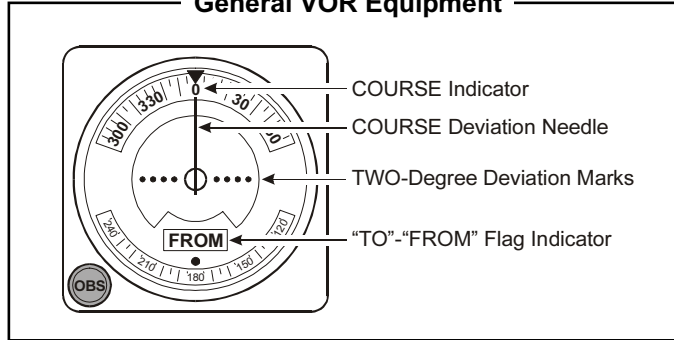

COM BAND

(118.0000 - 136.9750 MHz)

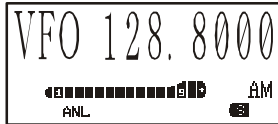

NAV BAND (108.0000 - 117.9750 MHz)

VOR MODE

COURSE Indicator



'TO' - 'FROM' Flag Indicator

CDI MODE

COURSE Indicator

COURSE Deviation Needle

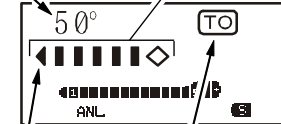

OVERFLOW Indicator 'TO' - 'FROM' Flag Indicator

VOR NAVIGATION (AIR BAND)

To Select the VOR Mode

- ❑ When entering the NAV band (108.000 - 117.975 MHz), the **VXA-710** selects the VOR mode automatically. The “Course Indicator” will appear on the display, and the “TO” or “FROM” indicator will appear at the right of the “Course Indicator” on the display.
Note: The “COURSE INDICATOR” indicates “--°” when either your aircraft is too far away from the VOR station or if the frequency is not correctly set to that of the VOR station. Conversely, the “Course Indicator” will indicate “Loc” when a localizer signal is being received.
- ❑ The “TO” or “FROM” flag indicators indicate whether the VOR navigation information is based on a course leading to the VOR station or leading away from the VOR station.
- ❑ To change the flag from “TO” to “FROM” or vice versa, press the **(F)** key followed by the **(FRM 3)** key or **(TO CD 2)** key, respectively.
- ❑ The (small) frequency indication may be toggled to display using larger characters (but “COURSE INDICATOR” and “TO”/“FROM” flag are reduced in size), if you assign the “XFER” feature to the **(USER)** key. See page 40 for details.

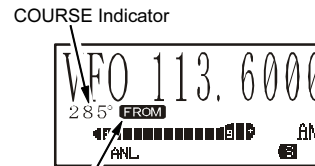

“TO” - “FROM” Flag Indicator

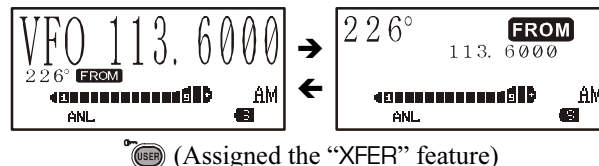
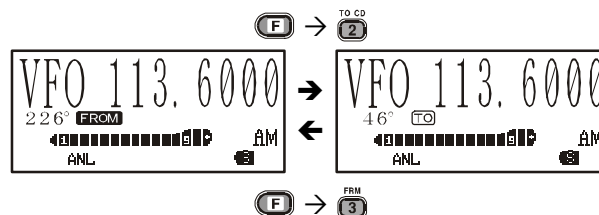

VOR NAVIGATION (AIR BAND)

Flying to a VOR Station

The **VXA-710** can indicate the deviation from the direct course to a VOR station.

- ❑ Select a VOR station on your aeronautical chart and turn the **DIAL** selector knob (or enter the frequency directly with the keypad) to the frequency of the VOR station.
- ❑ To indicate the deviation between your current flight path and the desired course, press the **(F)** key followed by the **(4)** key to change to the CDI (Course Deviation Indicator) mode. The “**COURSE DEVIATION ARROW**” will appear on the display when your aircraft is off the direct course to the VOR station.
- ❑ When your aircraft is off course to the **right**, the Course Deviation Arrow display will show bars to the left side of the diamond (“**|||◇**”). When your aircraft is off course to the **left**, the Course Deviation Arrow display will show bars to the right side of the diamond (“**◇|||**”). Correct your course until no bars appear on either side of the CDI “diamond” (only “**◇**”) will be visible when the heading is correct).
- ❑ To return to the DVOR mode, press the **(F)** key followed by the **(1)** key.

The Aircraft is “ON COURSE”

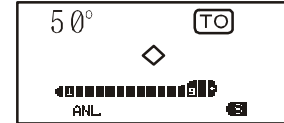

OFF COURSE to the “right” 6 degrees

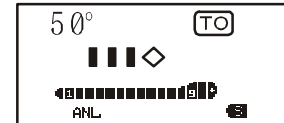

OFF COURSE to the “left” 6 degrees

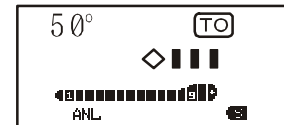

VOR NAVIGATION (AIR BAND)

The Aircraft is "ON COURSE"

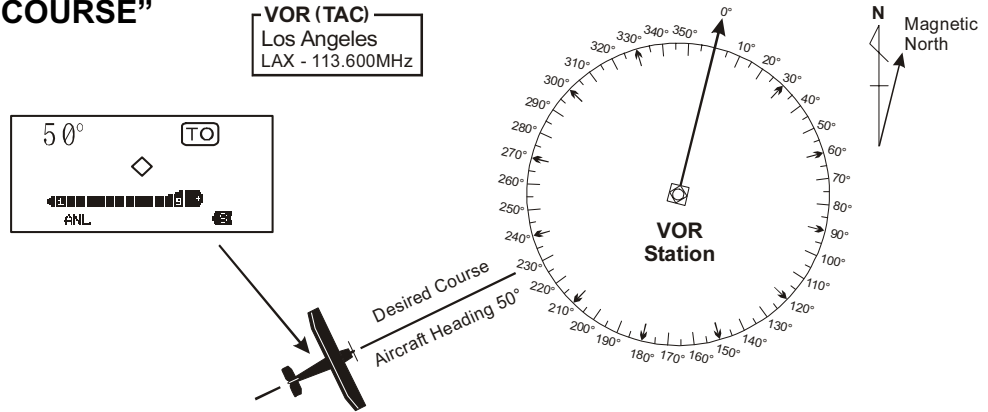

The Aircraft is "OFF COURSE"

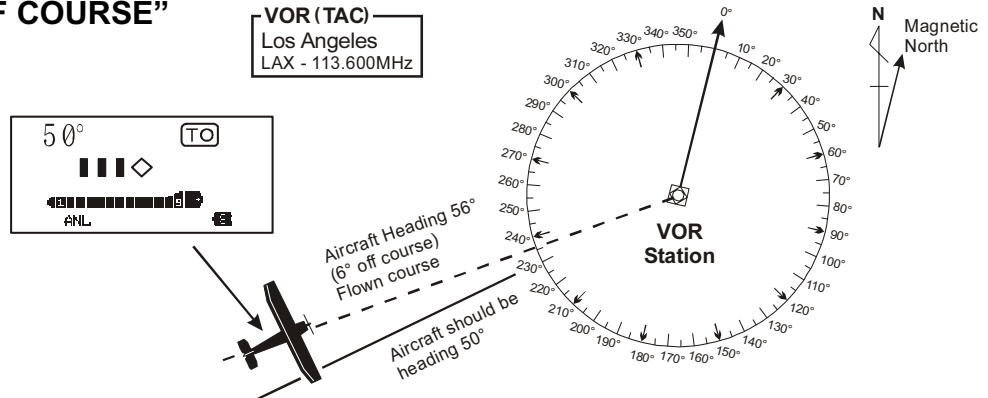

VOR NAVIGATION (AIR BAND)

Entering a Desired Course

The **VXA-710** can also be configured to indicate the deviation from the desired course, not only the deviation from the path to the VOR station.

- Set the frequency to the desired VOR station.
- Change the “TO” or “FROM” indication to “TO,” if it is not in that mode already.
- Press the **(F)** key followed by the **(CDI REV 4)** key to change to the CDI mode.
- Set the desired course to the VOR station using the **DIAL** selector knob or keypad (three-digit input; e.g. for 47°, press **(SO 0)** → **(CDI REV 4)** → **(SPL ST 7)**).

Note 1: The (“|||◇”) or (“◇|||”) indication will appear on the display when your aircraft is off the desired course.

Note 2: When your heading is correct, the **ABCS** function (see below) may be more useful than the course input option.

- The Course Deviation Arrow points to the right when your aircraft is off course to the left, and it points to the left when your aircraft is off course to the right.

Note 1: To get back on course, fly right more than the number of degrees indicated by the **COURSE DEVIATION ARROW**.

Note 2: If the overflow indicator “▶” appears on the right side, select a heading plus 10 degrees to the desired course; if the overflow indicator “◀” appears on the left side, select a heading minus 10 degrees.

Auto Bearing Center System (ABCS) Mode

In the CDI mode, the Auto Bearing Center System (ABCS) adds or subtracts the number of degrees indicated by the CDI from the Omni Bearing Selector (OBS).

VOR NAVIGATION (AIR BAND)

Position Cross-checking



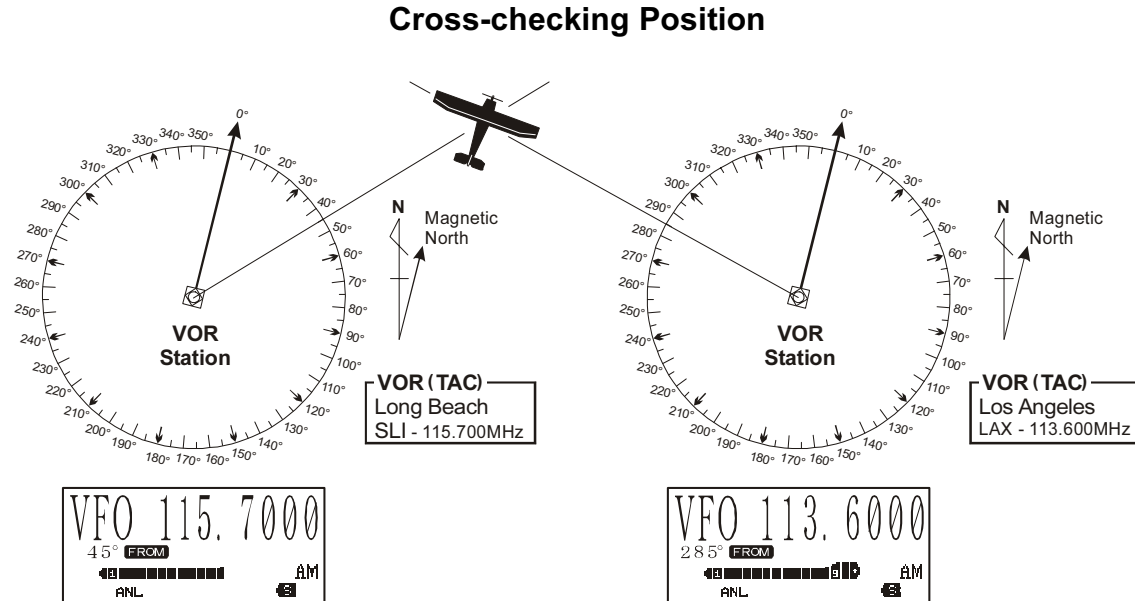

- ❑ Select two VOR stations on your aeronautical chart.
- ❑ Set the frequency of one of the VOR stations in the VOR mode. The course indicator will show the course deviation from the VOR radial. Note the radial you currently are on.
- ❑ Now set the frequency of the other VOR station in the VOR mode. Note the radial from the station you are on.
- ❑ Extend the radials from each VOR station on the chart. Your aircraft is located at the point where the lines intersect.





VOR NAVIGATION (AIR BAND)

Split Operation

The split operation feature allows you to transmit a call to a Flight Service Station using the COM band frequencies, while receiving a VOR station (in the NAV band). VOR stations equipped with this capability typically are shown, on navigation charts, with the voice calling frequency in parenthesis above the navigation frequency.

- Press the  key, repeatedly if necessary, to select the VFO mode.
- Set the desired VOR station's frequencies in the NAV band (108.000 - 117.975 MHz) using the **DIAL** selector knob or keypad.
- Press the  key followed by the  key. The “” icon will blink, and the transmit frequency will appear on the display.
- Now set your radio's transmit frequency, where the Flight Service Station will be listening for calls, using the **DIAL** selector knob or keypad.

- Press and hold in the  key for 2 seconds to save the transmit frequency and return to the NAV band frequency.
- Press and hold in the **PTT** switch to transmit on the split transmit frequency.
- Release the **PTT** switch to return to the receive mode.
- To disable the “Split” function, set the receiving frequency to any frequency outside of the NAV band (the “” icon will disappear).

Note: A split frequency can be programmed into each memory channel independently. Set a transmit frequency before programming the memory channel, if desired. The split function on/off setting can also be programmed into a memory channel.

BRS (BUSINESS RADIO SERVICE) CHANNEL OPERATION

Recalling the BRS Channels

- ❑ Press the **SET SEL** key, repeatedly if necessary, until “BRS” (Business Radio Service) appears on the display. In the BRS mode, you will see the previously-selected channel number appearing at the bottom of the “BRS” icon on the LCD.
- ❑ Rotate the **DIAL** selector knob to select the desired BRS channel.
- ❑ You may engage a CTCSS/DCS “Decoder” temporarily during BRS operation. Refer to the next chap-

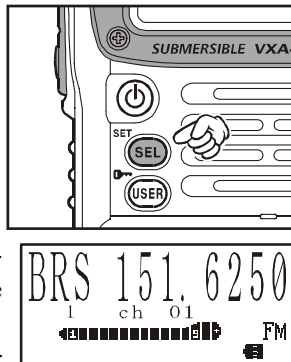

BRS BAND FREQUENCY CHART

Channel	Frequency	Channel	Frequency
BRS 1	151.6250 MHz	BRS 12	151.7750 MHz
BRS 2	151.9550 MHz	BRS 13	151.8650 MHz
BRS 3	154.5700 MHz	BRS 14	151.8950 MHz
BRS 4	154.6000 MHz	BRS 15	151.9250 MHz
BRS 5	151.7000 MHz	BRS 16	152.7000 MHz
BRS 6	151.7600 MHz	BRS 17	154.4900 MHz
BRS 7	151.5125 MHz	BRS 18	154.5150 MHz
BRS 8	151.6550 MHz	BRS 19	154.5400 MHz
BRS 9	151.6850 MHz	BRS 20	154.6000 MHz
BRS 10	151.7150 MHz	BRS 21	154.6550 MHz
BRS 11	151.7450 MHz	BRS 22	158.4000 MHz

ters for information on how this may enhance operation.

- ❑ To exit the BRS mode, press the **SET SEL** key momentarily to return to the VFO mode.

CTCSS Operation

The **VXA-710** can be used to silently monitor for calls on busy channels of the BRS band. The CTCSS decoder monitors receiver audio through a narrow filter at the same subaudible frequency, keeping the squelch closed until a matching tone is received.

The CTCSS setup involves two actions: setting the **Tone Mode** and then setting of the **Tone Frequency**. These actions are set up by using the **VOR T_N** (1) and **TO CD** (2) keys, or Menu Items (SQL Type) and (TONE Set).

- ❑ Press and hold the **VOR T_N** (1) key for 3 seconds. This instantly recalls Menu Item (SQL Type).
- ❑ Press the **SET SEL** key again to enable adjustment of this Menu Item.
- ❑ Rotate the **DIAL** selector knob so that “TSQ” to appears; this means that the CTCSS Decoder is active, which mutes your **VXA-710**'s receiver until it receives a call from another radio sending out a matching CTCSS tone. This can help keep your radio quiet until a specific call is received, which may be helpful

BRS (BUSINESS RADIO SERVICE) CHANNEL OPERATION

while operating in congested areas.

Note: You may notice an additional “DCS” icon appearing while you rotate the **DIAL** selector knob in this step. We’ll discuss the Digital Code Squelch system shortly.

- ❑ When you have made your selection of the CTCSS Tone Mode, press the **SEL** key momentarily, then rotate the **DIAL** selector knob one click clockwise to select Menu Item (TONE Set). This Menu selection allows setting of the CTCSS Tone Frequency to be used.
- ❑ Press the **SEL** key to enable the adjustment of the CTCSS Tone Frequency.
- ❑ Rotate the **DIAL** selector knob until the display indicates the CTCSS Tone Frequency you need to be using.
- ❑ When you have made your selection, press the **SEL** key to save the new setting, then press the **PTT** key repetitively until the radio exits to normal operation.

The “**TSQ**” icon will appear at the bottom of the display when the CTCSS Decoder is activated.

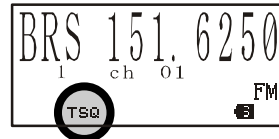

Note: The **VXA-710** will not “remember” the CTCSS Tone Mode and Tone Frequency. If you would like to maintain the CTCSS information permanently, we recommend you store the channel information, including the CTCSS data, into a Memory Channel. See page 20 for details regarding Memory storage.





CTCSS TONE FREQUENCY (Hz)							
67.0	69.3	71.9	74.4	77.0	79.7	82.5	85.4
88.5	91.5	94.8	97.4	100.0	103.5	107.2	110.9
114.8	118.8	123.0	127.3	131.8	136.5	141.3	146.2
151.4	156.7	162.2	167.9	173.8	179.9	186.2	192.8
203.5	210.7	218.1	225.7	233.6	241.8	250.3	—

BRS (BUSINESS RADIO SERVICE) CHANNEL OPERATION

DCS Operation

Another form of tone access control is Digital Code Squelch, or DCS. It is a newer, more advanced tone system which generally provides more immunity from false paging than does CTCSS Decoder. The DCS Decoder is built into your **VXA-710**, and operation is very similar to that just described for CTCSS Decoder.

Note: Just as in CTCSS Decoder, DCS Decoder requires that you set the ***Tone Mode*** to DCS and that you select a ***“Tone” Code***.

- Press and hold the  key for 2 seconds. This instantly recalls Menu Item (SQL Type).
- Press the  key again to enable adjustment of this Menu Item.
- Rotate the **DIAL** selector knob until “DCS” appears on the display; this activates the DCS Decoder.
- Press the  key momentarily, then rotate the **DIAL** selector knob two clicks clockwise to select Menu Item (DCS Set).
- Press the  key again to enable adjustment of this Menu Item.
- Rotate the **DIAL** selector knob to select the DCS code (a 3-digit number).

- When you have made your selection, press the  key to save the new setting, then press the **PTT** key repetitively until the radio exits to normal operation.

The “**DCS**” icon will appear at the bottom of the display when the DCS Decoder is activated.

Note: The **VXA-710** will not “remember” the DCS on/off status and DCS Code. If you would like to maintain the



DCS information permanently, we recommend you store the channel information, including the DCS data, into a Memory Channel. See page 20 for details regarding Memory storage.



DCS CODES									
023	025	026	031	032	036	043	047	051	053
054	065	071	072	073	074	114	115	116	122
125	131	132	134	143	145	152	155	156	162
165	172	174	205	212	223	225	226	243	244
245	246	250	251	252	255	261	263	265	266
271	274	306	311	315	325	331	332	343	346
351	356	364	365	371	411	412	413	423	431
432	435	445	446	452	454	455	462	464	465
466	503	506	516	523	526	532	546	565	606
612	624	627	631	632	654	662	664	703	712
723	731	732	734	743	754	—	—	—	—

BRS (BUSINESS RADIO SERVICE) CHANNEL OPERATION

CTCSS/DCS Bell Operation

During CTCSS Decoder or DCS Decoder operation, you may set the **VXA-710** up such that a ringing “bell” sound alerts you to the fact that a call is coming in. Here is the procedure for activating the CTCSS/DCS Bell:

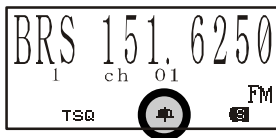
- Set the transceiver up for CTCSS Decoder or DCS Decoder operation, as described previously.
- Press the **(F)** key, then press the **(SEL)** key to activate the Menu (“SET”) mode.
- Rotate the **DIAL** selector knob to select Menu Item “2. Sound,” then press the **(SEL)** key.
- Rotate the **DIAL** selector knob to select Sub Menu Item “2. Bell,” then press the **(SEL)** key.
- Press the **(SEL)** key again to enable adjustment of this Menu Item.
- Rotate the **DIAL** selector knob to select “ON” (to enable the CTCSS/DCS Bell).
- Press the **(SEL)** key to save the new setting, then press the **PTT** key repetitively until the radio exits to normal operation.

When the CTCSS/DCS Bell feature is enabled, the “The image shows a rectangular digital display from a radio. The top line displays "BRS 151.6250". Below this, the text "1 ch 01" is visible. At the bottom left, "TSQ" is shown. At the bottom right, "FM" is shown. In the center of the bottom row, there is a bell icon (a bell inside a circle) which is highlighted with a larger, darker circle. To the right of the bell icon is a small square icon with a bell inside.

station calls you whose transceiver is sending a CTCSS tone or DCS code which matches that set into your decoder, the “

38

MISCELLANEOUS SETTINGS

Automatic Power-Off (APO) Feature

The APO feature helps conserve battery life by automatically turning the radio off after a user-defined period of time within which there has been no dial or key activity. The available selections for the time before power-off are 0.5/1/8 hours, as well as APO Off.

The default condition for the APO is OFF, and here is the procedure for activating it:

- Press the **[F]** key, then press the **[SET SEL]** key to activate the Menu (“SET”) mode.
- Rotate the **DIAL** selector knob to select Menu Item “6. Misc Setup,” then press the **[SET SEL]** key.
- Rotate the **DIAL** selector knob to select Sub Menu Item “1. APO,” then press the **[SET SEL]** key.
- Press the **[SET SEL]** key again to enable adjustment of this Menu Item.
- Rotate the **DIAL** selector knob to select the desired time period after which the radio will automatically shut down.
- When you have made your selection, press the **[SET SEL]** key to save the new setting, then press the **PTT** key repetitively until the radio exits to normal operation.

When the APO is activated, the “**[PWR]**” icon will appear at the center bottom on the LCD. If there is no action by you

within the time interval programmed, the microprocessor will shut down the radio automatically.



Just press and hold in the **[PWR]** switch for 3 seconds to turn the transceiver back on after an APO shutdown, as usual.

Transmitter Time-Out Timer (TOT)

The TOT feature provides a safety switch which limits transmission to a pre-programmed value. This will promote battery conservation by not allowing you to make excessively-long transmissions, and in the event of a stuck **PTT** switch (perhaps if the radio or a Speaker/Mic is wedged between aircraft’s seats) it can prevent interference to other users as well as battery depletion. As configured at the factory the TOT feature is set to OFF, and here is the procedure for activating it:

- Press the **[F]** key, then press the **[SET SEL]** key to activate the Menu (“SET”) mode.
- Rotate the **DIAL** selector knob to select Menu Item “4. Transmit,” then press the **[SET SEL]** key.
- Rotate the **DIAL** selector knob to select Sub Menu Item “1. T.O.T.” then press the **[SET SEL]** key.
- Press the **[SET SEL]** key again to enable adjustment of this



MISCELLANEOUS SETTINGS

Menu Item.



- Rotate the **DIAL** selector knob to set the Time-Out Timer to the desired “Maximum TX” time (1 minute, 3 minutes or 5 minutes).
- When you have made your selection, press the  key to save the new setting, then press the **PTT** key repetitively until the radio exit to normal operation.



Note: Because battery life is significantly enhanced by making only brief transmissions from your radio, try setting your **VXA-710**'s TOT function to time out at one minute.

Programming the Key Assignments

The  key is a user-programmable key that may be set up for a pair of functions you use particularly frequently. The default  key functions, as set up at the factory, have been assigned to the ANL feature (press key) and to the “Large Font” feature (press and hold key) at the factory. These may be changed by the user, if you wish to utilize another function or functions.

To program the function assigned to a key:

- Press the  key, then press the  key to activate the Menu (“SET”) mode.
- Rotate the **DIAL** selector knob to select Menu Item “5. Key Set,” then press the  key.

- Rotate the **DIAL** selector knob to select Sub Menu Item “3. USER 1” (for the “press key” function) or “4. USER 2” (for the “press and hold key” function), then press the  key.
- Press the  key again to enable adjustment of this Menu Item.
- Rotate the **DIAL** selector knob to select the function you wish to assign to the button you selected in the previous step. The available choices are:
 - ANL: Activates the Automatic Noise Limiter in the AM mode.
 - XFER: Exchanges the display locations between the “frequency” and “Alpha-numeric Tag” modes while operate on the “Memory,” “Book Memory,” and “WX” modes. This also may be used to exchange the display location between the “frequency” and “Course Indicator and TO/FROM flag” options while operating on the “NAV” band.
 - SPEC Start: Activates the Spectrum Scope Monitor feature.
 - Large Font: Switches the frequency display between the “Large Character” and “Small Character” modes.
 - None

MISCELLANEOUS SETTINGS

- ❑ When you have made your selection, press the **SET** key to save the new setting, then press the **PTT** key repetitively until the radio exits to normal operation.

Display Customization

Display Contrast

The LCD's contrast may be adjusted using the Menu.

- ❑ Press the **F** key, then press the **SET** key to activate the Menu ("SET") mode.
- ❑ Rotate the **DIAL** selector knob to select Menu Item "1. Display," then press the **SET** key.
- ❑ Rotate the **DIAL** selector knob to select Sub Menu Item "4. Contrast," then press the **SET** key.
- ❑ Press the **SET** key again to enable adjustment of this Menu Item.
- ❑ Rotate the **DIAL** selector knob to adjust the contrast. As you make the adjustment, you will be able to see the effects of your changes.
- ❑ When you have made your selection, press the **SET** key to save the new setting, then press the **PTT** key repetitively until the radio exits to normal operation.

Display Dimmer

The LCD illumination may be adjusted using the Menu, as well.

- ❑ Press the **F** key, then press the **SET** key to activate the Menu ("SET") mode.
- ❑ Rotate the **DIAL** selector knob to select Menu Item "1. Display," then press the **SET** key.
- ❑ Rotate the **DIAL** selector knob to select Sub Menu Item "5. Dimmer," then press the **SET** key.
- ❑ Press the **SET** key again to enable adjustment of this Menu Item.
- ❑ Rotate the **DIAL** selector knob to adjust the display illumination for a comfortable brightness level. As you make the adjustment, you will be able to see the effects of your changes.
- ❑ When you have made your selection, press the **SET** key to save the new setting, then press the **PTT** key repetitively until the radio exits to normal operation.

MISCELLANEOUS SETTINGS

TX/BUSY Indicator Customization

Default **TX/BUSY** illumination colors have been assigned at the factory. These may be changed by the user, if you wish to utilize another custom-designed color hue. The Red, Green, and Blue elements of each color's composition may be adjusted individually!

- Press the **F** key, then press the **SEL** key to activate the Menu ("SET") mode.
- Rotate the **DIAL** selector knob to select Menu Item "1. Display," then press the **SEL** key.
- Rotate the **DIAL** selector knob to select Sub Menu Item "8. RX LED" when you wish to change the **BUSY** indicator's color, or Sub Menu Item "9. TX LED" when you wish to change the **TX** indicator's color, then press the **SEL** key.
- Press the **SEL** key again to enable adjustment of the selected Menu item.
- Rotate the **DIAL** selector knob to adjust the "R" (red) element of the color; you will be able to see the effects of your changes. The degree of color hue is designated in a numerical scale of "000" through "255," and you may adjust the display's red component until it is just the way you want it. As you make the adjustment, you will be able to see the effects of your changes.



- Press the **SEL** key again, then rotate the **DIAL** selector knob to adjust the "G" (green) element of the color.
- Repeat the process described above to adjust the "B" (blue) element of the color.
- Press the **SEL** key to save the new setting, then press the **PTT** key repetitively until the radio exits to normal operation.

Note: You may also change the indicator's color of the Emergency lamp, Weather Alert lamp, and Over-Heating lamp by the Menu Items. See page 49 for details.

MISCELLANEOUS SETTINGS

Changing the Channel Steps

The **VXA-710** allows you to choose channel steps in the FM broadcast band: 5/10/12.5/15/20/25/50/100 kHz per step. The **VXA-710** is set up at the factory to 100 kHz which probably is satisfactory for most operation. However, if you need to change the channel step increments, the procedure to do so is very easy.







- Press and hold in the  key for 2 seconds. This instantly recalls Menu Item (Step).
- Press the  key again to enable adjustment of this Menu Item.
- Rotate the **DIAL** selector knob select the new channel step size.
- When you have made your selection, press the  key to save the new setting, then press the **PTT** key repetitively until the radio exit to normal operation.

Note: The **VXA-710** does not allow you to change the channel steps in the Air band. On the Air band, the steps are fixed at 25 kHz/step.





FIELD PROGRAMMING MODE

The **VXA-710**'s "Book" Memories also allow the user to store, label, and recall channel frequencies which you may want to use frequently by placing the **VXA-710** into the "*Field Programming mode.*"

Memory Storage





- ❑ Press and hold in both the **PTT** switch and  key, while turning the radio on, to activate the Field Programming Mode. "FD" will appear at the upper left corner on the display.
- ❑ Select the desired frequency to be stored in the Book Memory.
- ❑ Press and hold in the  key for 2 seconds. The display will indicate a "Book" memory channel number will blink on the LCD.
- ❑ Within five seconds of releasing the  key, rotate the **DIAL** selector knob to select the desired memory channel number for storage. In order to prevent writing over memory channels, a " icon will appear at the right of the channel number to indicate if the memory channel is vacant.
- ❑ Now press and hold in the  key for 3 seconds; you will now see the blinking "A" character on the LCD. To attach an alpha/numeric name (label) to the memory, proceed to the next step; otherwise press and hold in the  key for 2 seconds to save the entry and

exit.

- ❑ To label a memory with an alpha/numeric name, the next step is to use the **DIAL** selector knob to select any of the 125 available characters (including letters, numbers, and special symbols). Press the  key repeatedly to recall the desired letter, number, and symbol in the first character slot (a → . → □ → A → a ...). When the desired first character appears, press the  key momentarily to select it and move on to the next character.
- ❑ Select succeeding characters in the same manner, pressing the  key momentarily after each selection.
- ❑ After entering the entire name (eight characters maximum), press the  key for 2 seconds to save all data for the channel.
- ❑ Turn the radio off, then turn the radio back on again to begin normal operation.

FIELD PROGRAMMING MODE

Deleting Memories

- ❑ Press and hold in both the **PTT** switch and  key, while turning the radio on, to activate the Field Programming Mode. “FD” will appear at the upper left corner on the display.
- ❑ Press and hold in the  key for 2 seconds. The display will indicate a “Book” memory channel number will blink on the LCD.
- ❑ Within five seconds of releasing the  key, rotate the **DIAL** selector knob to select the memory channel number you wish to delete.
- ❑ Press the  key momentarily. The previously-selected memory will be deleted.
- ❑ Turn the radio off, then turn the radio back on again to begin normal operation.

CPU RESETTING

In some instances of erratic or unpredictable operation, the cause may be corruption of data in the microprocessor (due to static electricity, etc.). If this happens, resetting of the microprocessor may restore normal operation. Note that all memories will be erased if you do a complete microprocessor reset, as described below.

To clear all memories and other settings to factory defaults:

1. Turn the radio off.
2. Press and hold in the  key, and the **MONITOR** button, while turning the radio on.

TIMER MODE

The **VXA-710** provides both “STOP WATCH” and “COUNT DOWN” timers. These may be used for a variety of time-keeping purposes.







1. Press and hold in the  key while tuning the radio on, to activate the Timer Mode.
2. Press the **MONITOR** key to toggle the Timer between “STOP WATCH” timer and “COUNT DOWN” timer. If you select the “COUNT DOWN” timer, rotate the **DIAL** knob to set the values for the timers (1 minutes –59 minutes).
3. Press the **PTT** switch to start/stop the timer.
4. Turning the radio off, then on again, will return the **VXA-710** to normal operation.



MENU (“SET”) MODE

The Menu system allows certain aspects of your radio’s configuration to be customized for your personal operating convenience. We do not recommend that any of the default settings be changed, however, until you are thoroughly familiar with the operation of the **VXA-710**.

Here is the procedure for initiating Menu configuration changes:

- Press the  key, then press the  key, to activate the Menu (“SET”) mode.
- Rotate the **DIAL** selector knob to select the “Main” Menu, then press the  key.
- Rotate the **DIAL** selector knob to select the “Sub” Menu item you wish to view and/or modify, then press the  key.
- Once you have selected the desired Menu Item, press the  key once to view the current setting for the item.
- Rotate the **DIAL** selector knob to change the setting of the item (ON to OFF, etc.).
- Press the  key again to save your new setting.
- Press the **PTT** key repetitively until the radio exits to normal operation.

MENU (“SET”) MODE

MENU Listing

A listing of the Menu items available via the SET mode may be found below.

Set Mode Item	Function	Available Values (Default: <i>Bold Italic</i>)
1. Display	1. Scan Lamp	Enables/Disables the Scan lamp while paused during scanning. On / Off
	2. Backlight	Selects the Display illumination Mode. Key / Off / On
	3. Large Font	Selects the frequency display between the “Large Character” and “Small Character” modes. Off / On
	4. Contrast	Setting of the display contrast. 00 - 15 (06)
	5. Dimmer	Setting of the display brightness level. LV 1 – LV 4 (LV 3)
	6. Meter Symbol	Selects the S- & TX PO meter symbol. Four patterns
	7. Display Mode	Selects the display of the sensor units’ information. Off / Temp / Volt
	8. RX LED	Edits the BUSY indicator color. R: 000 - 255, G: 000 - 255, B: 000 - 255 (R: 000, G: 065, B: 000)
	9. TX LED	Edits the TX indicator color. R: 000 - 255, G: 000 - 255, B: 000 - 255 (R: 111, G: 000, B: 000)
	10. EMG LED	Edits the Emergency lamp color. R: 000 - 255, G: 000 - 255, B: 000 - 255 (R: 127, G: 127, B: 127)
	11. Alert LED	Edits the Weather Alert lamp color. R: 000 - 255, G: 000 - 255, B: 000 - 255 (R: 000, G: 127, B: 000)
	12. TEMP LED	Edits the Over Heating lamp color. R: 000 - 255, G: 000 - 255, B: 000 - 255 (R: 127, G: 000, B: 127)
2. Sound	1. Beeper	Select the Keypad beeper tone. On / DTMF / Off
	2. Bell	Enables/disables the Bell Ringer function. On / Off
	3. PowerOn Beep	Selects the Power-on beep. Off / 1 / 2 / 3
3. Receive	1. SQL	Sets the Squelch threshold level for the AM and FM modes. 0 - 8 (6)
	2. FM Radio SQL	Sets the Squelch threshold level for the FM BC Band. 0 - 8 (3)
	3.Resume	Selects the Scan Resume mode. 5secs / Busy
	4. DW/PRI	Selects the Dual Watch/Priority Function. DW / PRI
	5. RX Save	Selects the Receive-mode Battery Saver “sleep” ratio. ABS/1:1/1:2/1:3/1:4/1:5/Off
	6. Step	Setting of the synthesizer steps. 5k / 10k / 12.5k / 15k / 20k / 25k / 50k / 100k
	7. PRI Time	Selects the Priority Checking Time. 500ms / 1s / 1.5s / 2s / 2.5s / 3s
	8. SPECT Width	Selects the visible bandwidth of the Spectrum Analyzer. ±30ch / ±15ch
	9. SQL Type	Selects the Tone Decoder mode. Off / TSQ / DCS
	10. TONE Set	Setting of the CTCSS Tone Frequency. 39 standard CTCSS tones (67.0 Hz)
	11. DCS Set	Setting of the DCS Code. 106 standard DCS codes (023)
4. Transmit	1. T.O.T	Setting of the Time-Out Timer Countdown Time. Off / 1min / 3min / 5min
5. Key Set	1. Lock Mode	Selects the Control Locking lockout combination. DIAL / KEY / KEY+DIAL / PTT / DIAL+PTT / KEY+PTT / ALL
	2. [121.5]	Selects the primary [121.5(HOME)] key function 121.5 / HOME
	3. USER 1	Programming the [USER] key assignment (momentary-press mode). ANL / XFER / SPEC Start / Large Font / None
	4. USER 2	Programming the [USER] key (press and holding) assignment. ANL / XFER / SPEC Start / Large Font / None
6. Misc. Setup	1. APO	Selects the Auto Power Off time (time before power goes off). Off / 0.5h / 1h / 8h
	2. Emergency	Selects the Emergency feature. 121.5 / LED+121.5 / LED
	3. WX Alert	Selects the Alert functions when receiving the Weather Alert Signal on the WX Channel. Alert Off / Beep / LED / Beep+LED
	4. TEMP Unit	Selects the measurement units for the Temperature sensor. °F / °C
	5. TEMP Check	Enables/Disables the Over-Heating Alarm. Off / On
	6. TEMP Set	Program the threshold temperature for the “High-Temperature” indicator. [32.0 °F (0 °C)] – [230.0 °F (110 °C)] ([122.0 °F (50 °C)])
	7. Bandwidth	Selects the receiving bandwidth on the BRS Band. Wide/Narrow
7. Option	1. Internal MIC	Internal Microphone On/Off. Off / On
	2. TEMP Offset	Correcting the Thermometer setting. [-22.8 °F (-12.7 °C)] – [+22.8 °F (+12.7 °C)] ([0 °F (50 °C)])
	3. Clock Shift	CPU Clock Shift. Off / On

MENU (“SET”) MODE

1. DISPLAY

1. Scan Lamp

Function: Enables/Disables the Scan lamp while paused during scanning.

Available Values: On/Off

Default Setting: On

2. Backlight

Function: Selects the Display illumination Mode.

Available Values: Key/Off/On

Default Setting: Key

Key: Illuminates the Display Lamp for 5 seconds when any front panel key is pressed.

Off: Disables the Display lamp.

On: Illuminates the Display lamp continuously.

3. Large Font

Function: Selects the frequency display between the “Large Character” and “Small Character” modes.

Available Values: Off/On

Default Setting: On

4. Contrast

Function: Setting of the display contrast.

Available Values: 00 - 15

Default Setting: 06

5. Dimmer

Function: Setting of the display brightness level.

Available Values: LV 1 - LV 4

Default Setting: LV 3

6. Meter Symbol

Function: Selects the S- & TX PO meter symbol.

Available Values: Four patterns







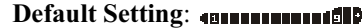

Default Setting: 

7. Display Mode

Function: Selects the display of the sensor units’ information.

Available Values: Off/Temp/Volt

Default Setting: Off

Off: Disables the sensor information.

Temp: Indicates the current temperature inside the transceiver’s case.

Volt: Indicates the battery voltage and battery type.

MENU (“SET”) MODE

8. RX LED

Function: Edits the BUSY indicator color.

Available Values: Individual adjustments of the Red, Green, and Blue color hue may be performed, on a numerical scale of “000” to “255.” See page 42 for details.

Default Setting: Green (R000, G065, B000)

9. TX LED

Function: Edits the TX indicator color.

Available Values: Individual adjustments of the Red, Green, and Blue color hue may be performed, on a numerical scale of “000” to “255.” See page 42 for details.

Default Setting: Red (R111, G000, B000)

10. EMG LED

Function: Edits the Emergency lamp color.

Available Values: Individual adjustments of the Red, Green, and Blue color hue may be performed, on a numerical scale of “000” to “255.” See page 42 for details.

Default Setting: White (R127, G127, B127)

11. Alert LED

Function: Edits the Weather Alert lamp color.

Available Values: Individual adjustments of the Red, Green, and Blue color hue may be performed, on a numerical scale of “000” to “255.” See page 42 for details.

Default Setting: Green (R000, G127, B000)

12. TEMP LED

Function: Edits the Over Heating lamp color. This is a display seen when the temperature exceeds the threshold set via the “TEMP Set” setting (see page 53).

Available Values: Individual adjustments of the Red, Green, and Blue color hue may be performed, on a numerical scale of “000” to “255.” See page 42 for details.

Default Setting: Light Blue (R127, G000, B127)

2. SOUND

1. Beeper

Function: Select the Keypad beeper tone.

Available Values: On/DTMF/Off

Default Setting: On

On: Enables the keypad beeper.

DTMF: Enables the keypad beeper with DTMF tones.

Off: Disables the keypad beeper.

2. Bell

Function: Enables/disables the Bell Ringer function.

Available Values: On/Off

Default Setting: Off

MENU (“SET”) MODE

3. Power On Beep

Function: Selects the Power-on beep.

Available Values: Off/Mode 1/Mode 2/Mode 3

Default Setting: Mode 1

3. RECEIVE

1. SQL

Function: Sets the Squelch threshold level for the AM and FM Narrow modes.

Available Values: 0 - 8

Default Setting: 6

2. FM Radio SQL

Function: Sets the Squelch threshold level for the FM BC Band.

Available Values: 0 - 8

Default Setting: 3

3. Resume

Function: Selects the Scan Resume mode.

Available Values: 5secs/Busy

Default Setting: 5secs

5secs: The scanner will hold for 5 seconds, then resume whether or not the other station is still transmitting.

Busy: The scanner will hold until the signal disappears, then will resume when the carrier drops.

4. DW/PRI

Function: Selects the Dual Watch/Priority Function.

Available Values: DW/PRI

Default Setting: DW

5. RX Save

Function: Selects the Receive-mode Battery Saver “sleep” ratio.

Available Values: ABS/1:1/1:2/1:3/1:4/1:5/Off

Default Setting: ABS

The setting of “1:5” will promote the greatest conservation of battery capacity, but the receiver’s response time to incoming calls will be slowed somewhat.

ABS: Automatic Battery Saver, based on activity on the receiver.

Note: This feature cannot be activated during Scan or Dual Watch/Priority operation.

6. Step

Function: Setting of the synthesizer steps.

Available Values: 5k/10k/12.5k/15k/20k/25k/50k/100k

Default Setting: Depends on the operating band.

MENU (“SET”) MODE

7. PRI Time

Function: Selects the Priority Checking Time.

Available Values: 500ms/1s/1.5s/2s/2.5s/3s

Default Setting: 2s

This Menu Item allows you to define how often the Priority Channel will be checked for activity.

Note: The Dual Watch Polling time is 500ms (fixed).

8. SPECT Width

Function: Selects the visible bandwidth of the Spectrum Analyzer.

Available Values: ±30ch/±15ch

Default Setting: ±30ch

9. SQL Type

Function: Selects the Tone Decoder mode.

Available Values: Off/TSQ/DCS

Default Setting: Off

TSQ: CTCSS Decoder

DCS: Digital Coded Squelch Decoder

Note: This Menu Item may only be used on BRS Memory channels (it will not engage on other bands or channels).

10. TONE Set

Function: Setting of the CTCSS Tone Frequency.

Available Values: 39 standard CTCSS tones.

Default Setting: 67.0Hz

11. DCS Set

Function: Setting of the DCS Code.

Available Values: 106 standard DCS codes.

Default Setting: 023

CTCSS TONE FREQUENCY (Hz)							
67.0	69.3	71.9	74.4	77.0	79.7	82.5	85.4
88.5	91.5	94.8	97.4	100.0	103.5	107.2	110.9
114.8	118.8	123.0	127.3	131.8	136.5	141.3	146.2
151.4	156.7	162.2	167.9	173.8	179.9	186.2	192.8
203.5	210.7	218.1	225.7	233.6	241.8	250.3	–

DCS CODE									
023	025	026	031	032	036	043	047	051	053
054	065	071	072	073	074	114	115	116	122
125	131	132	134	143	145	152	155	156	162
165	172	174	205	212	223	225	226	243	244
245	246	250	251	252	255	261	263	265	266
271	274	306	311	315	325	331	332	343	346
351	356	364	365	371	411	412	413	423	431
432	435	445	446	452	454	455	462	464	465
466	503	506	516	523	526	532	546	565	606
612	624	627	631	632	654	662	664	703	712
723	731	732	734	743	754	–	–	–	–

MENU (“SET”) MODE

4. TRANSMIT

1. T.O.T

Function: Setting of the Time-Out Timer Countdown Time.

Available Values: Off/1min/3min/5min

Default Setting: Off

The Time-Out Timer shuts off the transceiver after continuous transmission exceeds the programmed time.

5. KEY SET

1. Lock Mode

Function: Selects the Control Locking lockout combination.

Available Values: DIAL/KEY/KEY+DIAL/PTT/DIAL+PTT/KEY+PTT/ALL

Default Setting: KEY

2. [121.5]

Function: Selects the  key function.

Available Values: 121.5/HOME

Default Setting: 121.5

121.5: Pressing this key instantly recall a 121.5 MHz “Emergency” channel.

HOME: Pressing this key instantly recalls a favorite “Home” channel.

3. USER 1

Function: Programming the  key assignment (momentary-press mode).

Available Values: ANL/XFER/SPEC Start/Large Font/None

Default Setting: ANL

See page 40 for details.

4. USER 2

Function: Programming the  key (press and holding) assignment.

Available Values: ANL/XFER/SPEC Start/Large Font/None

Default Setting: Large Font

See page 40 for details.

6. MISC SETUP

1. APO

Function: Selects the Auto Power Off time (time before power goes off).

Available Values: Off/0.5h/1h/8h

Default Setting: Off

MENU (“SET”) MODE

2. Emergency

Function: Selects the Emergency feature.

Available Values: 121.5/LED+121.5/LED

Default Setting: LED+121.5

121.5: Pressing the  key momentarily accesses the 121.5 MHz Emergency Frequency.

LED+121.5: Pressing the  key momentarily accesses the 121.5 MHz Emergency Frequency and flashes the **BUSY/TX** lamp.

LED: Pressing the  key momentarily flashes the **BUSY/TX** lamp.

3. WX Alert

Function: Selects the Alert functions when receiving the Weather Alert Signal on the WX Channel.

Available Values: Alrt Off/Beep/LED/Beep+LED

Default Setting: Alrt Off

Alrt Off: Disables the Alert function

Beep: Sounds a loud beep when receiving the Weather Alert Signal.

LED: Illuminate the **BUSY/TX** lamp when receiving the Weather Alert Signal

Beep+LED: Sounds a loud beep and illuminates the **BUSY/TX** lamp when receiving the Weather Alert Signal.

4. TEMP Unit

Function: Selects the measurement units for the Temperature sensor.

Available Values: °F/°C

Default Setting: °F

5. TEMP Check

Function: Enables/Disables the Over-Heating Alarm

Available Values: Off/On

Default Setting: Off

6. TEMP Set

Function: When the “TEMP Check” Menu item is set to “On,” and the temperature passes through the threshold set in this step, the **BUSY/TX** indicator will change colors, to alert you to the high temperature condition. The color of the “High Temperature” indication is set via the “TEMP LED” Menu setting (page 49).

Available Values: [32.0 °F (0 °C)] - [230.0 °F (110 °C)]

Default Setting: [122.0 °F (50 °C)]

NOTE: When the temperature reaches approximately 220 °F (105 °C), the radio will disable transmission, to allow the radio to cool off.

MENU (“SET”) MODE

7. Bandwidth

Function: Selects the receiving bandwidth of the BRS Memory Channel.

Available Values: Wide (± 25 kHz)/Narrow (± 12.5 kHz)

Default Setting: Wide (± 25 kHz)

7. OPTION

1. Internal MIC

Function: Internal Microphone On/Off

Available Values: Off/On

Default Setting: Off

This controls the status of the radio’s internal microphone when an external microphone (such as the **MH-44A4B** Speaker Microphone or an aviation headset connected via the **CT-96** Headset Cable) is in use. In most applications, set this Menu Item to “Off” for proper operation (this disables the internal microphone). The internal microphone will still function normally when the external microphone is disconnected.

2. TEMP Offset

Function: Correcting the Thermometer setting

Available Values: [-22.8 °F (-12.7 °C)] - [$+22.8$ °F ($+12.7$ °C)]

Default Setting: 0.0 °F (0.0 °C)

This allows you to calibrate the internal thermometer with a known-to-be-accurate source.

3. Clock Shift

Function: CPU Clock Shift

Available Values: Off/On

Default Setting: Off

This function is only used to move a spurious response “birdie” should it fall on a desired frequency. Consult your Vertex Standard dealer for details regarding this function.

NOTE

SPECIFICATIONS

General

Frequency Range:	TX 118.000 - 136.975 MHz (COM Band) RX 88.000 - 108.000MHz (FM BC Band), 108.000 - 117.975 MHz (NAV Band), 118.000 - 136.975 MHz (COM Band), 151.5125 - 158.400MHz (BRS Memory Channels), Weather Channel (WX-01 - WX-10)
Channel Spacing:	25 kHz (AIR Band), 5/10/12.5/15/20/25/50/100 kHz (FM BC Band)
Emission Type:	TX: AM, RX: AM & FM
Supply Voltage:	4.5 - 15.0 VDC
Current Consumption (approx.):	250 μ A (Power off), 35 mA (Battery saver on, save ratio 1:5), 60 mA (Squelch on), 180 mA (Receive), 800 mA (Transmit AM: 1.5W Carrier @ 7.4V), 400 mA (Transmit AM: 0.3W Carrier @ 4.5V)
Temperature Range:	-22 °F to +140 °F (-30 °C to +60 °C)
Case Size (WxHxD):	2.36" x 3.78" x 1.12" (60 x 96 x 28.5 mm) w/FNB-80LI
Weight (approx.):	9.9 oz. (280 grams) with FNB-80LI, antenna

Specification are subject to change without notice.

SPECIFICATIONS

Receiver

Circuit Type:	Double-conversion Superheterodyne
IFs:	35.4 MHz & 450 kHz (AM / NFM), 45.65 MHz & 10.7MHz (WFM)
Sensitivity:	88-108 MHz: better than 2 μ V (for 12 dB SINAD with 1 kHz tone @ 22.5 kHz deviation) 108 MHz-137 MHz: better than 1 μ V (for 6 dB S/N with 1 kHz tone @ 30 % modulation) BRS-01 - BRS-21: better than 0.32 μ V (for 12 dB S/N with 1 kHz tone @ 3.5 kHz deviation) WX-01 - WX-10: better than 0.4 μ V (for 12 dB S/N with 1 kHz tone @ 3.5 kHz deviation)
Selectivity:	AM/FM: more than 8 kHz/−6 dB, WFM: more than 200 kHz/−6 dB
Adjacent Ch. Selectivity:	AM/FM: less than 25 kHz/−60 dB, WFM: less than 300 kHz/−20 dB
AF Output:	0.2 W @ 8 Ohms, 10 % THD @ 7.4V 0.4 W @ 8 Ohms, 10 % THD @ 13.8V

Transmitter

Power Output:	118 MHz-137 MHz: AM: 5.0 W (PEP), 1.5 W (Carrier Power) @ 7.4 V
Frequency Stability:	Better than ± 2.5 ppm (−22 °F to 140 °F/−30 °C to +60 °C)
Modulation System:	AM: Low Level Modulation
Spurious Emission:	Better than 60 dB below carrier
Int. Microphone Type:	Condenser
Ext. Mic. Impedance:	150 Ohms

ACCESSORIES & OPTIONS

Supplied Accessories

LI-ion Battery Pack (7.2V, 1300 mAh) FNB-80LI	1
Battery Charger NC-72	1
Helical Antenna ATV-14	1
Headset Cable CT-96	1
Operating Manual	1
Warranty Card	1

Available Options

MH-44B4B	Speaker Microphone
FBA-23	Alkaline Battery Case
CD-15A	Desktop Rapid Charger
E-DC-5B	DC Cable w/Noise Filter
E-DC-6	DC Cable; plug and wire only
CN-3	Antenna Adapter (SMA to BNC)

- *Availability of accessories may vary.*
- *Some accessories are supplied as standard per local requirements, while others may be unavailable in some regions.*
- *Consult your Vertex Standard Dealer for details regarding these and any newly-available options.*
- *Connection of any non-Vertex Standard-approved accessory, should it cause damage, may void the Limited Warranty on this apparatus.*
- *This product is designed to perform optimally when used with genuine Vertex Standard accessories. Vertex Standard shall not be liable for any damage to this product and/or accidents such as fire, leakage or explosion of a battery pack, etc., caused by the malfunction of non-Vertex Standard accessories.*

ACCESSORIES & OPTIONS

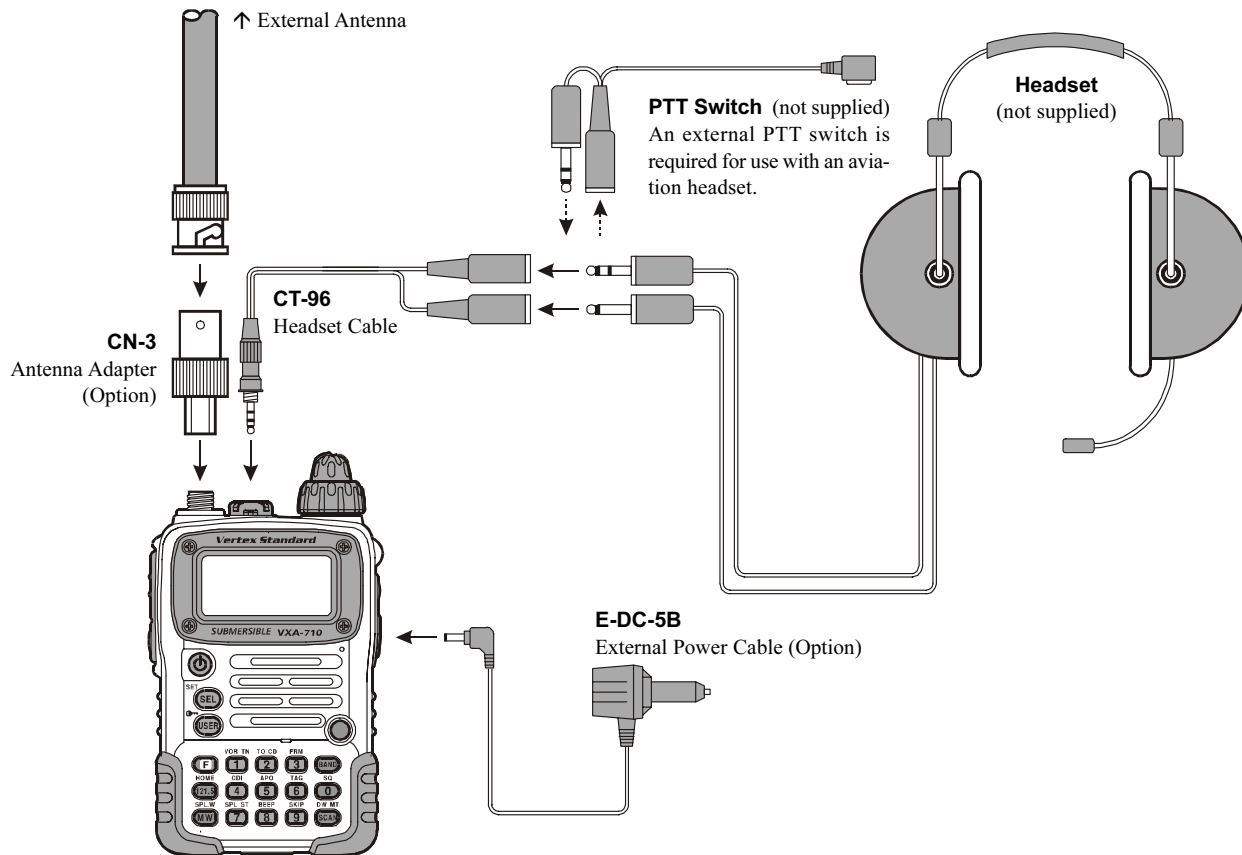

NOTE

Part 15.21: Changes or modifications to this device not expressly approved by Vertex Standard could void the user's authorization to operate this device.



VERTEX STANDARD CO., LTD.

4-8-8 Nakameguro, Meguro-Ku, Tokyo 153-8644, Japan

VERTEX STANDARD

US Headquarters

10900 Walker Street, Cypress, CA 90630, U.S.A.

YAESU EUROPE B.V.

P.O. Box 75525, 1118 ZN Schiphol, The Netherlands

YAESU UK LTD.

Unit 12, Sun Valley Business Park, Winnall Close
Winchester, Hampshire, SO23 0LB, U.K.

VERTEX STANDARD HK LTD.

Unit 5, 20/F., Seaview Centre, 139-141 Hoi Bun Road,
Kwun Tong, Kowloon, Hong Kong

0502A-AK

Copyright 2005

VERTEX STANDARD CO., LTD.

All rights reserved.

No portion of this manual may be
reproduced without the permission of
VERTEX STANDARD CO., LTD.

Printed in Japan

